

#myeasysmarthome

# THE SMART GUIDE FOR TRADE



Discover our **Smart Home** solutions

#LegrandImprovingLives

#legrandimprovinglives

## Take a tour of our **Easy Smart Home** guide

**Legrand has developed a wide range of easy-to-install solutions with Netatmo to meet your customers' needs and allow them to connect their homes easily.**

This practical guide has been created by Legrand to help you with your projects. In it you will find the main features of each product, installation diagrams, some handy tips, and a guide to setting up a smart installation and pairing devices.

Please contact **Legrand's Customer Service** department for any further information.

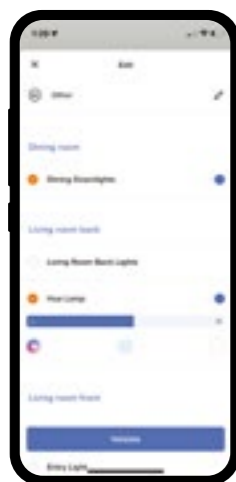
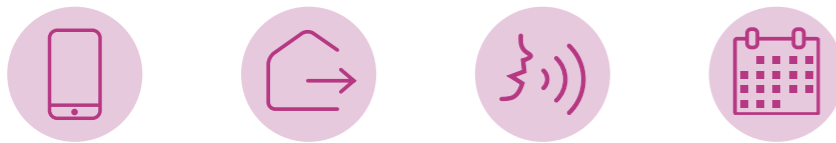

A single app for controlling all the Comfort and energy efficiency functions for Radio Zigbee or BUS/SCS installations.



An app dedicated to home security, with native integration of Netatmo security devices.



<b>System</b>	<b>2</b>	2 CONNECTED HOME, 2 SOLUTIONS
	<b>4</b>	CHOOSE THE RIGHT PRODUCTS FOR A SMART INSTALLATION
	<b>6</b>	PAIR THE GATEWAY WITH YOUR PRODUCTS
	<b>8</b>	PAIR SMART RADIO-CONTROLLED PRODUCTS AND WIRELESS SWITCHES
	<b>10</b>	PAIR SMART ACTUATORS AND BUS/SCS CONTROLS
<b>Solutions</b>	<b>11</b>	APPLICATIONS
	<b>14</b>	LIGHTING
	<b>23</b>	ROLLER SHUTTERS
	<b>23</b>	CEILING FANS
	<b>27</b>	HEATING
	<b>29</b>	ELECTRICAL APPLIANCES
	<b>32</b>	SCENARIOS
	<b>36</b>	FRAMES AND PLATE SELECTION CHARTS
	<b>40</b>	GREETING PEOPLE
	<b>43</b>	SECURITY
	<b>46</b>	DAY-TO-DAY WELLBEING
<b>47</b>	GATEWAYS FOR INSTALLATION CONNECTIVITY	
<b>Layout</b>	<b>52</b>	INSTALLATIONS TIPS
	<b>54</b>	EXAMPLE OF BUS/SCS AND RADIO ZIGBEE SMART INSTALLATION
	<b>56</b>	EXAMPLES OF SCENARIOS AND SCHEDULES
<b>Configuration</b>	<b>58</b>	START CONFIGURATION, PAIR DEVICES
	<b>60</b>	BUS/SCS INSTALLATION CONFIGURATION
	<b>64</b>	APPS: USEFUL INFORMATION
	<b>68</b>	INTEROPERABILITY

# 1 SMART HOME 2 SOLUTIONS

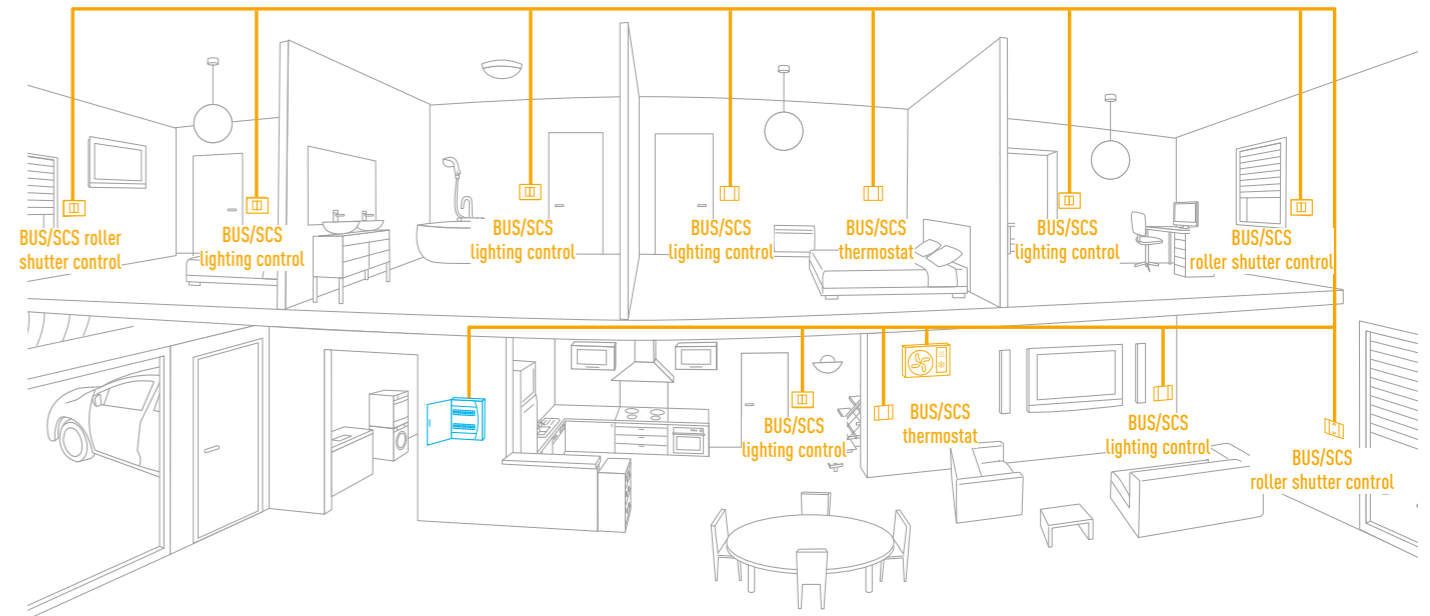
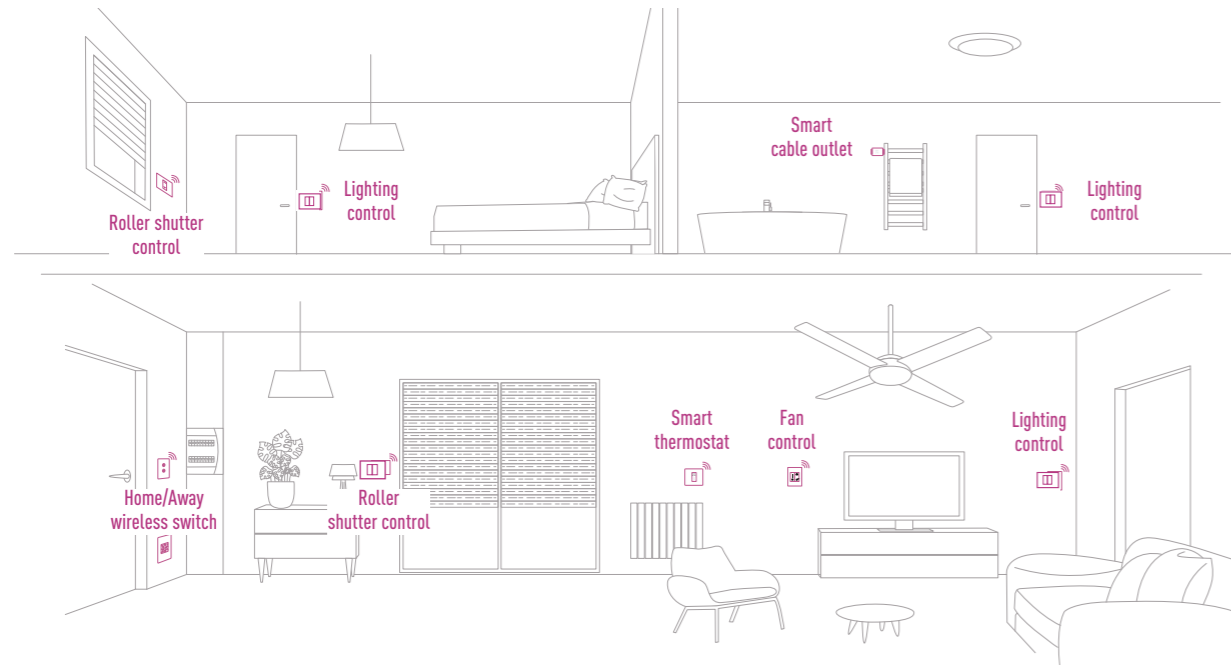

## RADIO INSTALLATION

- For new or refurbishment work on your buildings
- Up to 100 products per gateway
- Ideal for a site **of up to 150 m<sup>2</sup>**, even on several levels
- **Scalability:** possible to start with one room and then extend the installation
- **Simplicity:** add wireless switches that complete the installation without damage to the walls and are also paired and controlled from the app
- Wiring identical to a conventional unsmart installation

Wiring accessories with the same design throughout your installation, both indoors and outdoors

ARTEOR™  
with Netatmo

EXCEL  
Life  
SMART

Living Now  
with Netatmo



## A WIRED BUS/SCS INSTALLATION

- Ideal for new-build projects (or large refurbishment projects)
- Reliable, simple installation, **perfect over long distances**, via BUS/SCS with 2 non-polarised wires
- Numerous functions available to meet all the needs of a **spacious building** (lighting, shutters, heating)
- **Scalability:** possible to mix and complete the installation with Radio Zigbee products

Two designs available, Arteor and Living Now Digital Controls, to coordinate with the rest of your installation.

Living Now  
Digital Controls

ARTEOR™  
MyHome























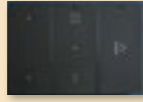

## HOME + CONTROL APP FOR CONTROLLING YOUR INSTALLATION, WHETHER RADIO-CONTROLLED OR WIRED

- Control, schedule, create scenarios via the app
- Also control products using your voice via voice assistants
- Manage consumption by viewing it in real time

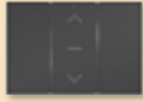

# CHOOSE THE RIGHT PRODUCTS FOR A SMART INSTALLATION

SMART PRODUCTS THAT REQUIRE INSTALLATION OF A GATEWAY  							
	LIGHTING	ROLLER SHUTTERS	CEILING FANS	HEATING AND HOT WATER	ELECTRICAL APPLIANCES	MANAGING ENERGY CONSUMPTION	ELECTRIC VEHICLE CHARGING
<b>RADIO ZIGBEE</b> Requires a Gateway power outlet or Gateway power module or Classe 300EOS	 Smart switch or dimmer (requires Neutral)  Smart wireless switch  Smart lighting micromodule  Smart latching relay	 Smart roller shutter switch  Micromodule for Smart roller shutter (wired shutters)	 Smart fan controller	 Smart cable outlet  Smart contactor (peak/off-peak times mode)	 Smart Single Power Point  Smart Outdoor single Powerpoint  Smart contactor (ON/OFF mode)  Connected dry contact	 Smart electricity meter <b>STAND-ALONE WIRELESS SWITCHES</b>  Wireless Master Switch  2 Gang Wireless Switch  1 Gang wireless switch	 Green'up EV charger can be controlled by a Smart contactor (ON/OFF mode or peak/off peak times model up to 20A)
	<b>BUS/SCS</b> Requires a Classe 300EOS gateway or BUS/SCS/MyHOME gateway	 BUS/SCS lighting actuator  BUS/SCS control  BUS/SCS control	 BUS/SCS roller shutter actuator  BUS/SCS blinds control  BUS/SCS blinds control	 BUS/SCS heating actuator  BUS SCS thermostat  BUS/SCS thermostat			

**+** CHOICE OF GATEWAY: RADIO OR BUS/SCS (pages 52 to 56) 



Starter kit (Gateway+Wireless Master Switch)

OR



Gateway power module

OR



Classe 300EOS audio/video door entry system

OR



BUS/SCS MyHOME gateway

# PAIR THE GATEWAY WITH YOUR PRODUCTS

WIRED PRODUCTS

## GATEWAYS



Installation with only Radio-controlled smart products	●	●	
Installation with only BUS/SCS MyHOME products			● ●

## STANDALONE SMART PRODUCTS

### GREETING PEOPLE

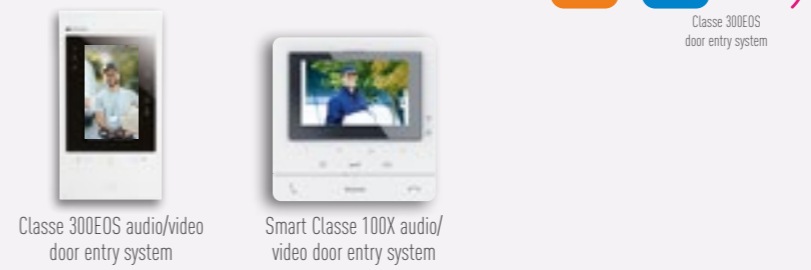

### HEATING



### SECURITY



### DAY-TO-DAY WELLBEING



## CONTROL FROM YOUR SMARTPHONE VIA AN APP



## VOICE CONTROL VIA A VOICE ASSISTANT



iOS: "with Netatmo" solutions require an iPhone, iPad or an iPod Touch. To control this HomeKit-compatible accessory, we recommend using the latest version of iOS or iPadOS. In order to control this HomeKit accessory automatically from outside the home, you need a HomePod, Apple TV or iPad configured as a hub. It is advisable to update to the latest version of both the software and the operating system. iPhone, iPod and iPad are trademarks of Apple Inc., registered in the United States and other countries. App Store is a trademark of Apple Inc., registered in the United States and other countries. HomeKit and iPadOS are trademarks of Apple Inc. iOS is a trademark of Cisco registered in the United States and other countries and used under licence.

ANDROID: Android 5.0 minimum required with Google Play access.

WEBAPP: PC & Mac

Google, Google Play and Android are trademarks of Google LLC. Amazon, Alexa and their associated logos are trademarks of Amazon.com, Inc or its subsidiaries.

# PAIR RADIO-CONTROLLED SMART PRODUCTS AND WIRELESS SWITCHES

	LIGHTING			HEATING	ROLLER SHUTTERS		ELECTRICAL APPLIANCES	
	Smart switches or dimmers	Smart lighting micromodule	Smart latching relay	Smart cable outlet (ON/OFF mode)	Smart roller shutter switch	Micromodule for connected roller shutter	10A smart single powerpoint	Smart contactor (ON/OFF mode)
Home/Away wireless master switch	●	●	●	●	●	●	●	●
Wake Up/Sleep wireless switch	●	●	●	●	●	●	●	●
4-scenario wireless switch	●	●	●	●	●	●	●	●
4-scenario pocket remote control	●	●	●	●	●	●	●	●
Wireless light and power outlet switch	●	●	●	●			●	●
Double wireless light and power outlet switch	●	●	●	●			●	●
IP44 wireless motion sensor	●	●	●	●			●	●
ON/OFF transmitter for switch or push-button	●	●	●	●			●	●
Wireless roller shutter switch					●	●		

# PAIR SMART ACTUATORS AND BUS/SCS CONTROLS



SMART ACTUATORS

## LIGHTING

- F411U2**  
2 x 10A ON/OFF outputs - 2 modules
- F411/4**  
4 x 2A ON/OFF outputs - 2 modules
- F418U2**  
Universal dimmer - 4 modules
- F413N**  
LED ballast/driver dimmer - 2 modules
- F429**  
DALI dimmer - 6 modules

## ROLLER SHUTTERS

- F411U2**  
2 x 10A ON/OFF outputs - 2 modules
- F411/4**  
4 x 2A ON/OFF outputs - 2 modules

## HEATING

- F430/2**  
2 independent relays - 2 modules
- F430/4**  
4 independent relays - 2 modules
- F430R8**  
8 independent relays - 4 modules
- F430R3V10**  
3 independent relays and 2 x 0-10 V outputs - 4 modules

# APPS

## HOME + CONTROL APP

## FOR USERS

- A single app for controlling Radio Zigbee or BUS/SCS installations
- For controlling lights, roller shutters, heating and electrical appliances remotely.
- Can also be used to personalise scenarios, schedule operation of appliances, track consumption in detail and set alerts on your smartphone.

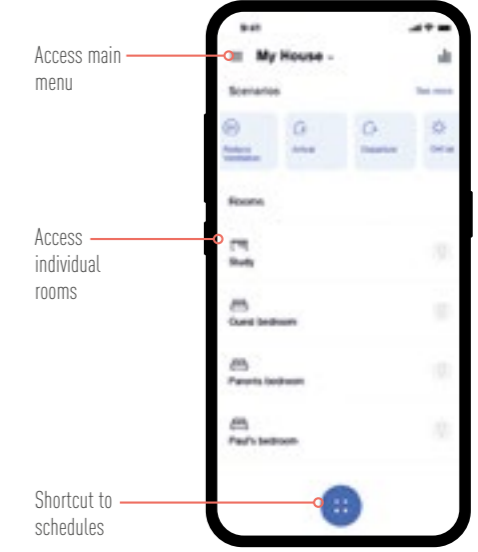
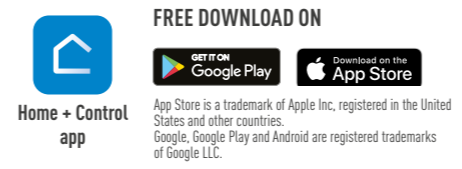

### CONTROL INDIVIDUAL ROOMS

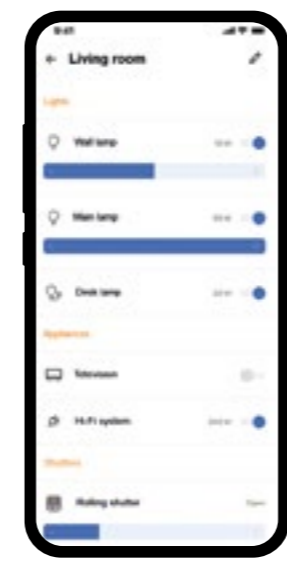

Displays the smart solutions in each room: lights, electrical appliances, heating, roller shutters, etc.

### DISPLAY POWER CONSUMPTION DATA

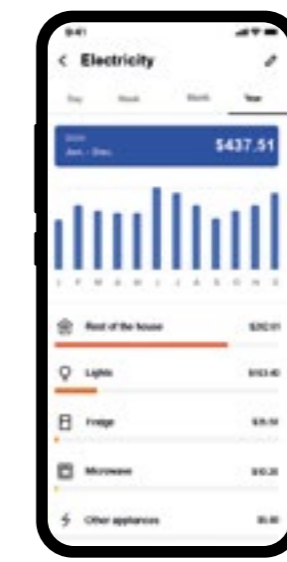

Displays total power consumption, in monetary cost and kWh usage, for each circuit and each appliance, with data history for the day/week, month and year

### CREATE SCHEDULES

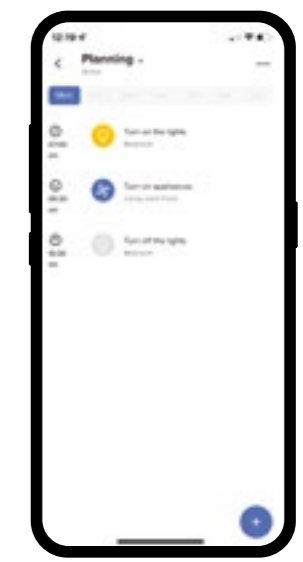

Schedules daily actions: shutter opening and closing, switching on the water heater, managing heating programmes, programming electric vehicle charging, etc.

# APPS (continued)

## HOME + SECURITY APP

## FOR USERS

- A single app for sending alerts in the case of events concerning the building security: intruder detection, etc.
- For responding to incoming video calls, enabling gate opening and viewing the Netatmo Smart Camera images.



Home + Security app

FREE DOWNLOAD ON



App Store is a trademark of Apple Inc, registered in the United States and other countries. Google, Google Play and Android are registered trademarks of Google LLC.

### OVERVIEW SCREEN FROM THE WELCOME SCREEN

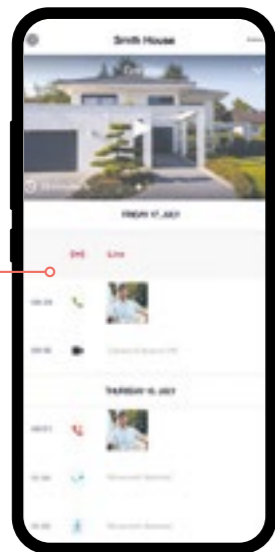

Event log and chronology by date

### INCOMING CALLS



Answer video calls at the door even when not at home

### REAL-TIME ALERTS

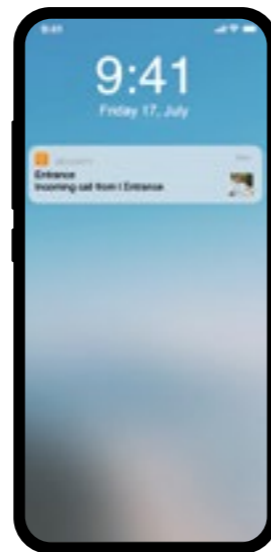

Receive a notification when someone rings the doorbell, or if someone is detected on your property.

## NATIVE INTEGRATION OF BTICINO SMART INTERCOM AND NETATMO SECURITY DEVICES

Solutions for complete smart services to protect your home



Classe300EOS



Classe100X16E Kit



Smart Indoor Camera



Smart Outdoor Camera



Smart Indoor Siren



Smart Opening Detectors for Doors and Windows

## HOME + PROJECT APP

## FOR THE INSTALLER

- Only for a BUS/SCS installation
- For designing and configuring the system simply:
  - Save time and easily duplicate your projects with the Copy/Paste function
  - Back up all your projects
  - Share them with your colleagues
- Allows you to hand over the system to your customer in working order and ready to use
- Available in WebApp version for PC and mobile version for smartphone.



Home + Project app

FREE DOWNLOAD ON



App Store is a trademark of Apple Inc, registered in the United States and other countries. Google, Google Play and Android are registered trademarks of Google LLC.

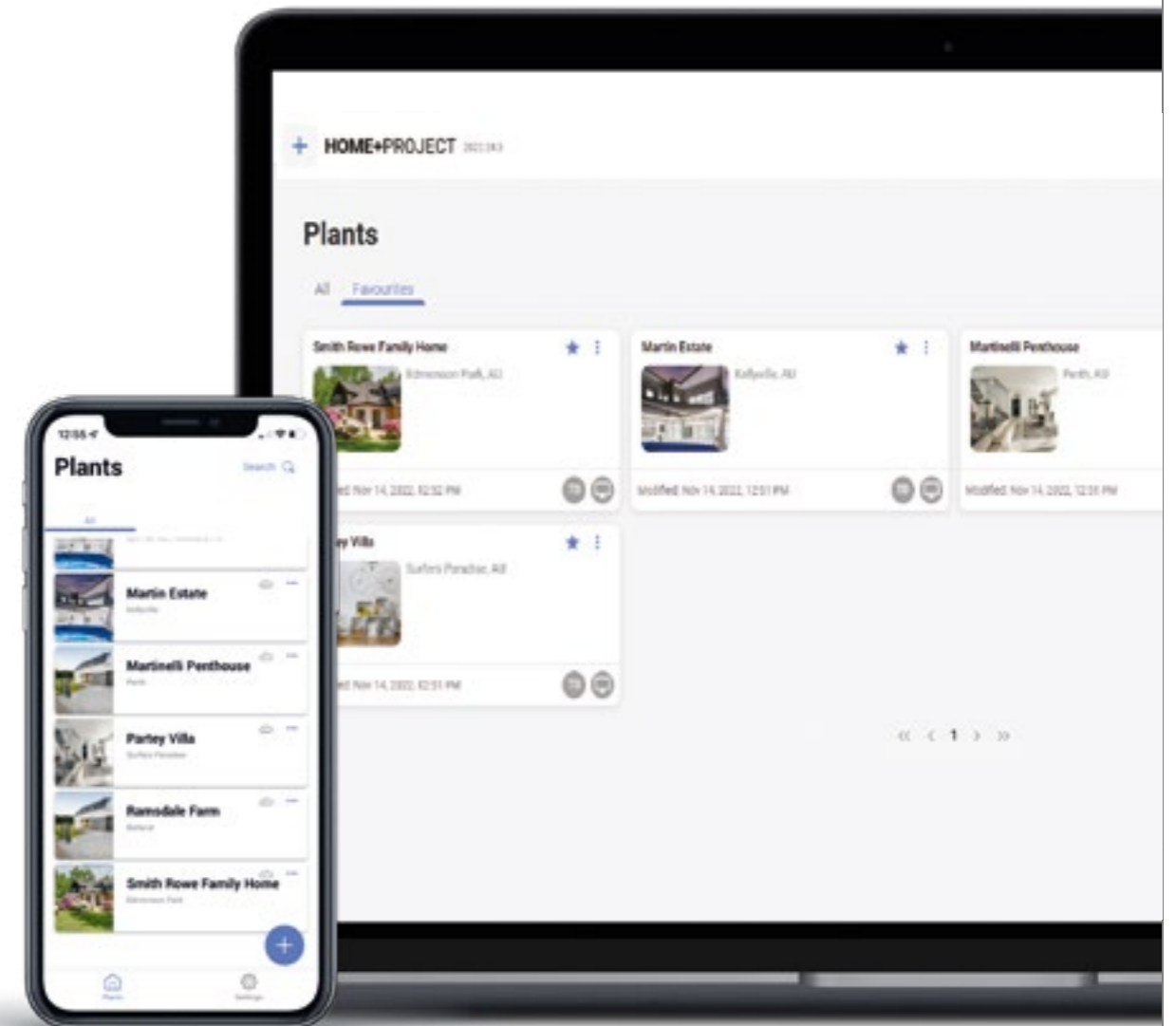





# LIGHTING

## SMART WIRED SWITCH AND DIMMER

- For controlling lights locally or remotely from a smartphone with the Home + Control app and using your voice with a voice assistant.
- The presence of the neutral wire ensures a stable current.

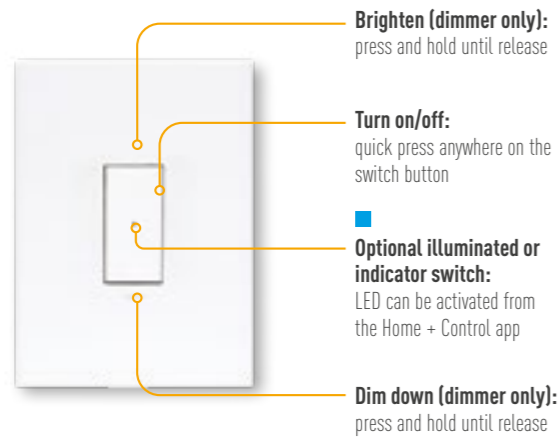

- INSTALLATION**  
Wall mount, Depth 40mm minimum required
- LAMPS**  
All types of standard and dimmable lamp, including dimmable LEDs, up to 150W (dimmer) or 100W (switch)
- REFURBISHMENT**  
Can replace an existing switch plate

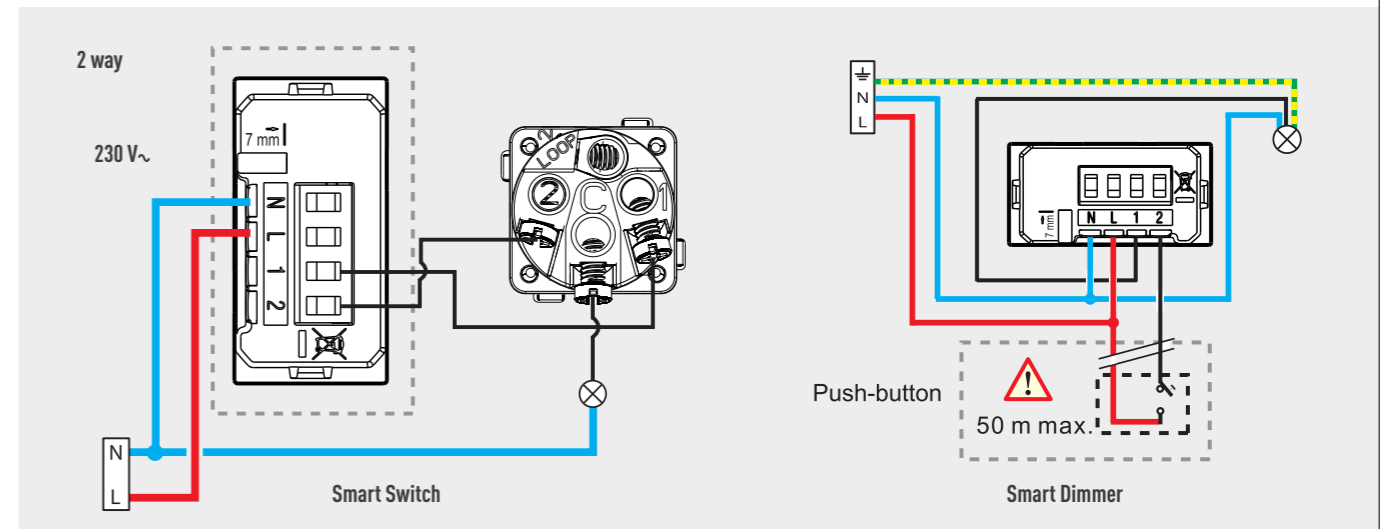
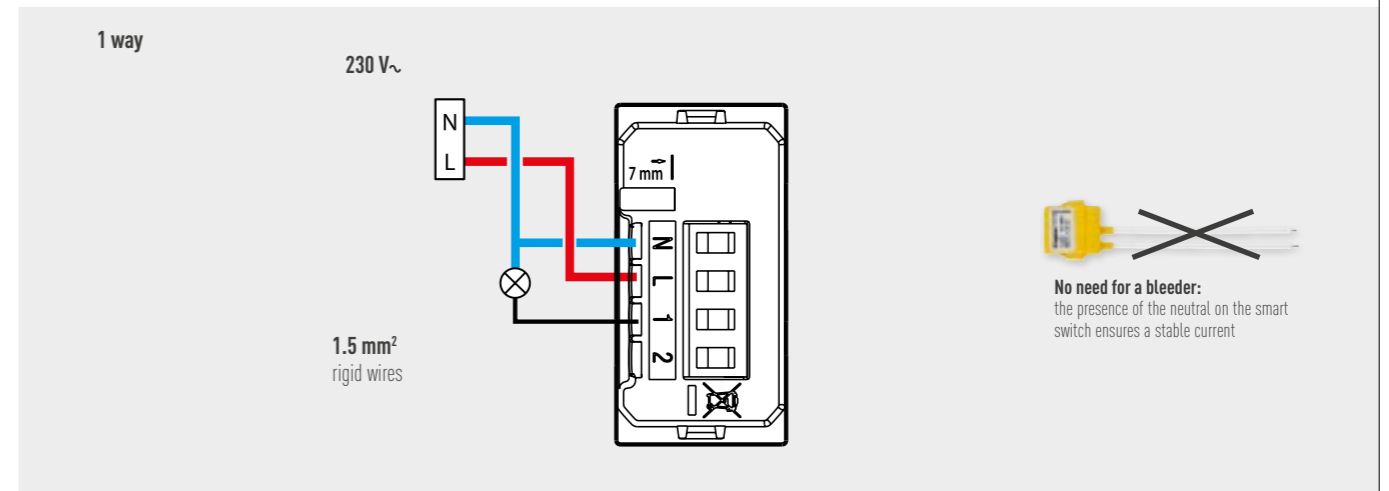

### Switch 1 Gang

EXCEL			ARTEOR™ with Netatmo				Living Now with Netatmo	
White	Matt White	Matt Black	White	Magnesium	Champagne	Aluminium	White	Black
EWN770/1WE	EWN770/1MW	EWN770/1MB	AWNVS1WE (vertical) AWNHS1WE (horizontal)	AWNVS1MGN (vertical) AWNHS1MGN (horizontal)	AWNVS1CHP (vertical) AWNHS1CHP (horizontal)	AWNVS1ALU (vertical) AWNHS1ALU (horizontal)	K4003C+KW01*	K4003C+KG01*

\*To be completed with support frame and coverplate. Refer p.40-43 for more information.

### Dimmer 1 Gang

EXCEL			ARTEOR™ with Netatmo				Living Now with Netatmo	
White	Matt White	Matt Black	White	Magnesium	Champagne	Aluminium	White	Black
EWNDIM1WE	EWNDIM1MW	EWNDIM1MB	AWNVD1WE (vertical) AWNHD1WE (horizontal)	AWNVD1MGN (vertical) AWNHD1MGN (horizontal)	AWNVD1CHP (vertical) AWNHD1CHP (horizontal)	AWNVD1ALU (vertical) AWNHD1ALU (horizontal)	K4411C+KW01*	K4411C+KG01*

\*To be completed with support frame and coverplate. Refer p.40-43 for more information.



# LIGHTING (continued)

## SMART LIGHTING MICROMODULE

- For making lighting smart for the controller locally from wireless switches, remotely from a smartphone with the Home + Control app and using your voice with a voice assistant.

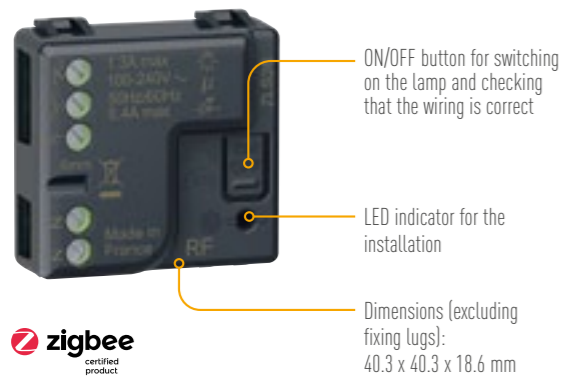

**INSTALLATION**  
Inside the wall or ceiling, in a junction box



**LAMPS**  
LEDs, compact fluorescent, up to 100 W, halogen up to 300 W



**REFURBISHMENT**  
Can make a light smart without wiring.

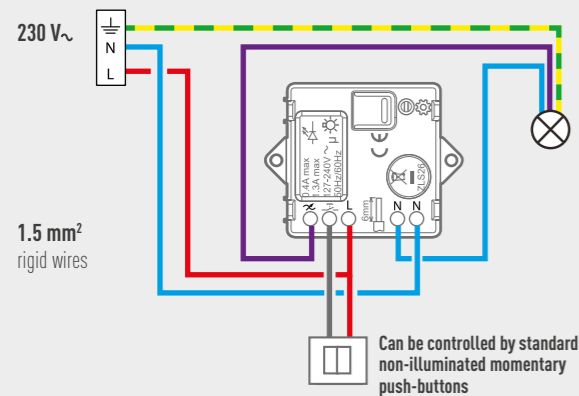

ARTEOR™  
with Netatmo

5 742 43

## SMART DIMMER MICROMODULE

- Convert a dimmable light into a smart light which can be controlled locally via a momentary switch, wireless switches, remotely via a smartphone with the Home + Control app, or using voice control assistant.

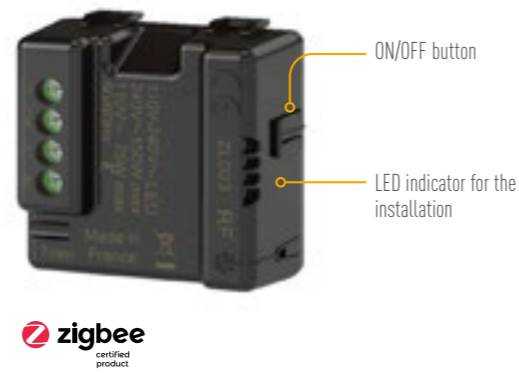

**INSTALLATION**  
Inside the wall or ceiling, in a junction box



**LAMPS**  
LEDs, compact fluorescent up to 150W



**REFURBISHMENT**  
Can make a light smart without wiring.

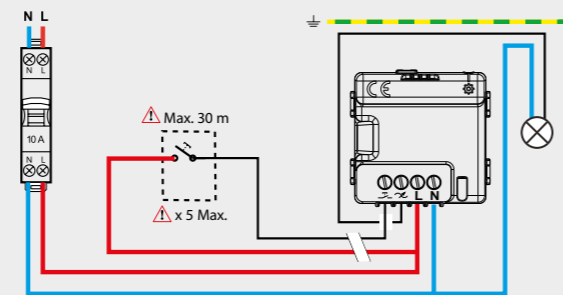

ARTEOR™  
with Netatmo

0 648 99

## SMART LATCHING RELAY

- For controlling lights with standard push-buttons and/or wireless switches from a smartphone with the Home + Control app and using your voice with a voice assistant.
- Can be used to monitor instantaneous and total power consumption (daily and monthly).
- Can also be used to control lighting via personalised schedules and scenarios.

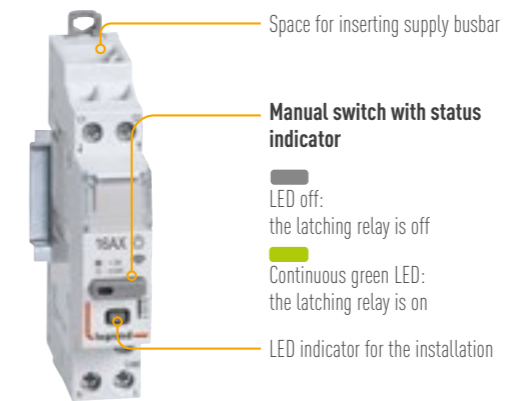

**INSTALLATION**  
Electrical panel. Width: 1 x 17.5 mm module



**LAMPS**  
LEDs, compact fluorescent: up to 650 W, halogen up to 3840 W



**REFURBISHMENT**  
Can replace an existing latching relay

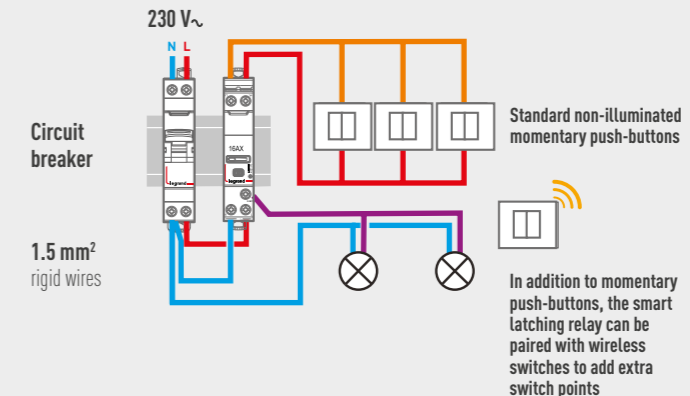

CX3  
with Netatmo

4 121 70



# LIGHTING (continued)

## BUS/SCS LIGHTING ACTUATOR AND CONTROL

- For controlling lights via a 2-wire control or remotely from a smartphone with the Home + Control app and using your voice with a voice assistant.

- Paired with the actuator, switches the lighting ON/OFF or dims it

### ACTUATOR



**BUS terminal block**  
Easily wired up with 2 wires.



**INSTALLATION**  
Electrical panel



### CONTROL

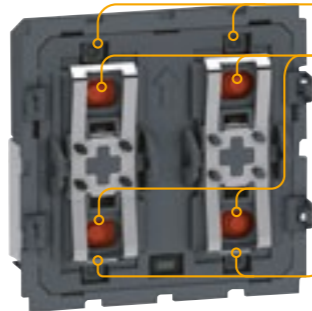

LED indicator  
Push-button

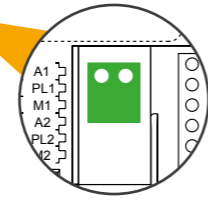

**BUS terminal block**  
Easily wired up with 2 wires



**INSTALLATION**  
Box depth 40 mm

- Simple parameter setting via the Home + Project app

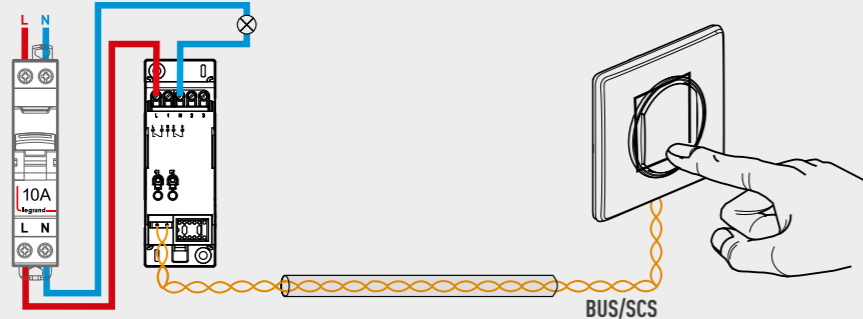

Cat. No.	①	②	③	④
F411U2 <sup>(1)</sup>	2300 W - 10A	460 W - 2A	920 W - 4A	920 W - 4A
F411/4 <sup>(1)</sup>	460 W - 2A	70 W 2 lamps max.	70 W - 0.3A	70 W - 0.3A (electronic) 460 VA 2 A cos φ 0.5 (ferromagnetic)
F418U2	2X300 W 1X600 W	2X300 VA/1x600 VA (dimnable)	-	2X300 VA 1X600 VA
F413N	-	-	460 W - 2A max. 10 ballast or driver for LED	-
F429	8x16 DALI ballast	-	-	-

① Incandescent/halogen lamps ② LED lamps, Compact fluorescent lamps  
③ Linear fluorescent lamps ④ Electronic/ferromagnetic transformers

	ARTEOR™ My Home	Living Now Digital Controls
Single/double/triple switch <sup>(2)</sup>	675 52	K8001 + KW8010 (White) or K68010 (Black)
Motion sensor	5 740 48	-

To be fitted with support frame, key covers and coverplates. Refer p.40-41 for more information.

## BUS/SCS LIGHTING ACTUATOR CONTROL

- For controlling loads directly (built-in actuator)
- Voice control

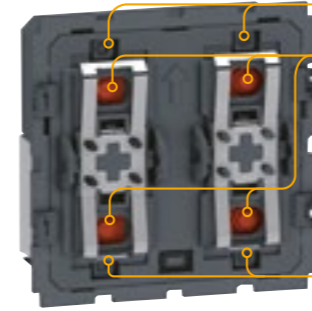

LED indicator  
Push-button

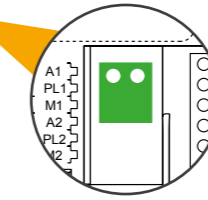

**BUS terminal block**  
Easily wired up with 2 wires



**INSTALLATION**  
Box depth 40 mm

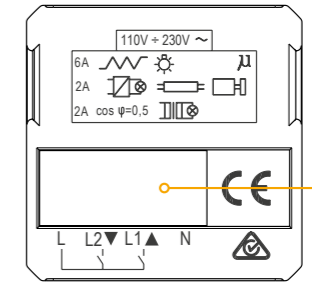

**Terminals**  
(3 x 2.5 mm<sup>2</sup>) for load connection

- 1 product to be wired up
- Simple parameter setting via the Home + Project app

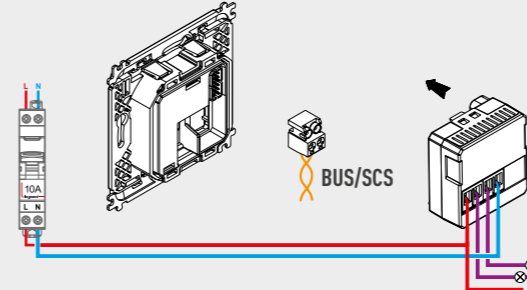

- 2 distinct parts that can be separated: 1 control part (load) and 1 contact part (BUS/SCS) that can be wired separately

Cat. No.	①	②	③	④	⑤
0 675 61 <sup>(1)</sup>	1380 W - 6A	230 W - 1A	460 W - 2A	70 W - 0.3A 460 VA - 2A	460 VA - 2A

ARTEOR™  
My Home

0 675 61

To be fitted with support frame, key covers and coverplates. Refer p.40-41 for more information

① Incandescent/halogen lamps ② LED lamps, Compact fluorescent lamps ③ Linear fluorescent lamps ④ Electronic transformers ⑤ Ferromagnetic transformers



# LIGHTING (continued)

## WIRELESS LIGHT SWITCH/DIMMER

- For adding an additional light switch or centralising the control of several lights and power outlets.
- Pair directly in the Home + Control app or by tapping the selected wired products: switch, micromodule, latching relay, power outlet and cable outlet.

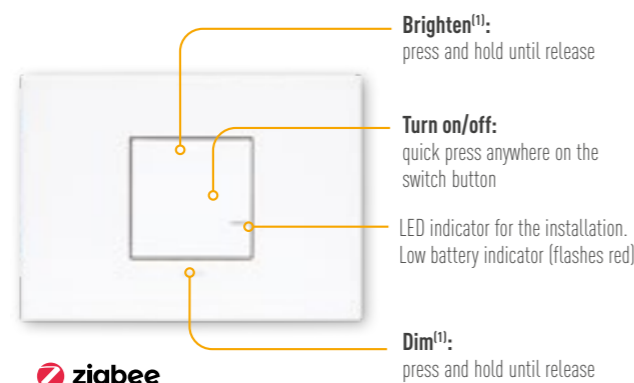

**INSTALLATION**  
Attaches to the wall using adhesive pads (supplied).  
Or can be screwed to wall



**POWER SUPPLY**  
3 V CR2032 lithium battery (supplied)  
Battery life: 8 years



**LOCATION**  
By a door, on a piece of furniture, etc



Extra-slim, attaches to the wall using the adhesive pads provided.  
Can be repositioned.  
Can also be screwed to a wall



ARTEOR™  
with Netatmo

Living Now  
with Netatmo

White	Matt White	Matt Black	White	Magnesium	Champagne	Aluminium	White	Black
EWNWSW1WE	EWNWSW1MW	EWNWSW1MB	AWNWSW1WE	AWNWSW1MGN	AWNWSW1CHP	AWNWSW1ALU	K4003CW+ KW42M2*	K4003CW+ KG42M2*

\*To be completed with coverplate. Refer p.42-43 for more information.

[1] Dimmer only option activated in the Home + Control app

## WIRELESS LIGHT SWITCH/DIMMER - CLIP-IN VERSION

- For adding an additional light switch or centralising the control of several lights and power outlets.
- Pair directly in the Home + Control app or by tapping the selected wired products: switch, micromodule, latching relay, power outlet and cable outlet.

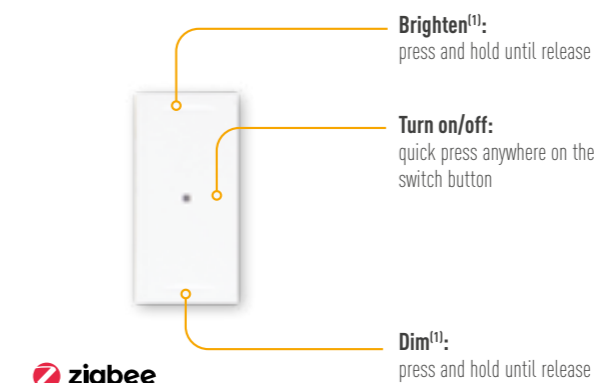

**LOCATION**  
Clipped into grid.



**POWER SUPPLY**  
3 V CR2032 lithium battery (supplied)  
Battery life: 8 years



Clips into grid like any other smart mechanisms.  
Can be repositioned



ARTEOR™  
with Netatmo

Living Now  
with Netatmo

White	Matt White	Matt Black	White	Magnesium	Champagne	Aluminium	White	Black
EWNWCWE EWNWCDWE <sup>(2)</sup>	EWNWCMW EWNWCDMW <sup>(2)</sup>	EWNWCMB EWNWCDB <sup>(2)</sup>	574291	574276	574326	574275	K4003CWI+ KW01	K4003CWI+KG01

To be completed with grid and coverplate. Refer p.40-43 for more information.

[1] When paired to a wired smart dimmer. [2] Dimmer version.



# LIGHTING (continued)

## 2 GANG WIRELESS LIGHT SWITCH

- For adding two additional light switches or centralising the control of several lights and power outlets.
- Pair directly in the Home + Control app or by tapping the selected wired products: switch, micromodule, latching relay, power outlet and cable outlet.

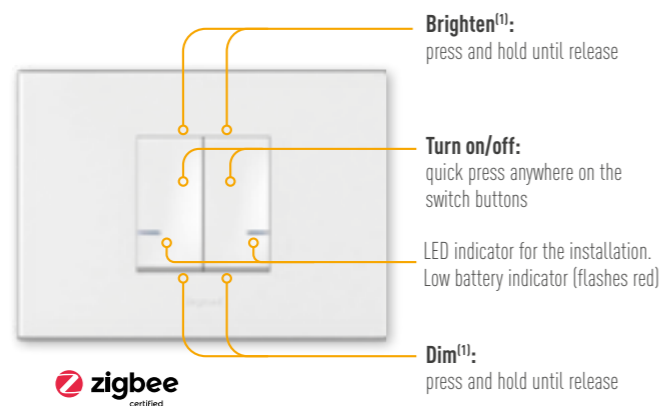

**INSTALLATION**  
Attaches to the wall using adhesive pads (supplied).  
Or can be screwed to wall

**POWER SUPPLY**  
3 V CR2032 lithium battery (supplied)  
Battery life: 8 years

**LOCATION**  
By a door, on a piece of furniture, etc



ARTEOR™  
with Netatmo

Living Now  
with Netatmo

White	Magnesium	Champagne	Aluminium	White	Black
AWNWSW2WE	AWNWSW2MGN	AWNWSW2CHP	AWNWSW2ALU	K4003DCW+KW36M2*	K4003DCW+KG36M2*

\*To be completed with coverplate. Refer p.42-43 for more information.

## WIRELESS MOTION SENSOR (IP44)

- For controlling one or more wired switches, micromodules, power outlets and cable outlets.
- Pair directly in the Home + Control app or by tapping the selected wired products.

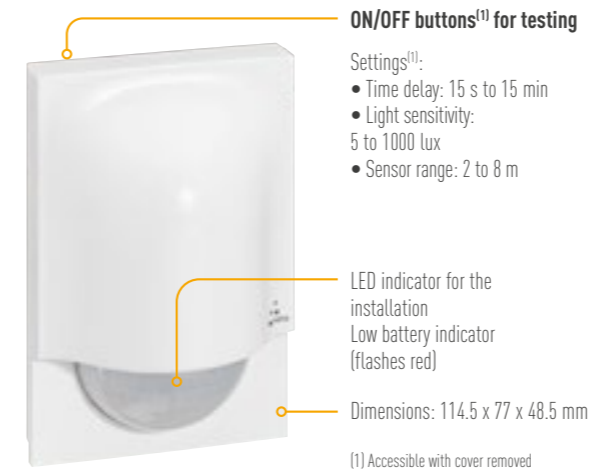

**INSTALLATION**  
Fixed onto a wall using 2 screws (not supplied)

**POWER SUPPLY**  
2 x 1.5 V AA batteries (supplied)  
Battery life: 2 years

**IP44**  
For indoors and outdoors

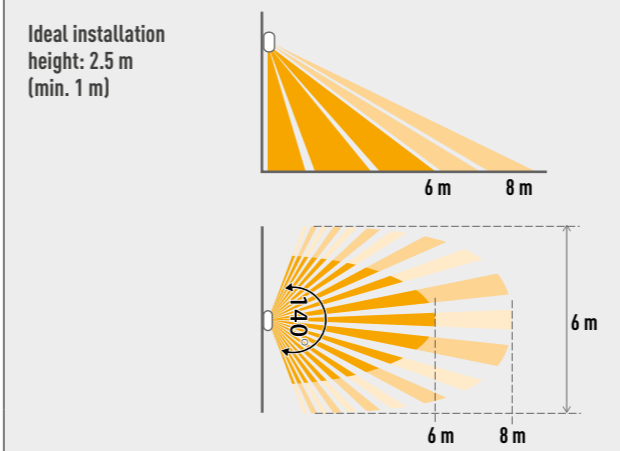

ARTEOR™  
with Netatmo

5 742 52

## ON/OFF TRANSMITTER FOR SWITCH OR PUSH-BUTTON

- For converting an existing standard switch or push-button to a connected wireless switch.
- Pair directly in the Home + Control app or by tapping the selected wired products: switch, micromodule, latching relay, power outlet and cable outlet.

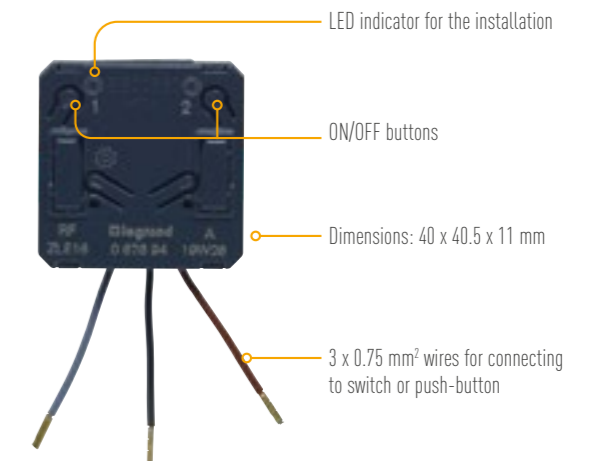

**INSTALLATION**  
Connects to the back of a standard switch or push-button

**POWER SUPPLY**  
3 V CR2032 lithium battery (supplied)  
Battery life: 8 years

### CONVERTING A STANDARD SWITCH TO A CONNECTED SWITCH

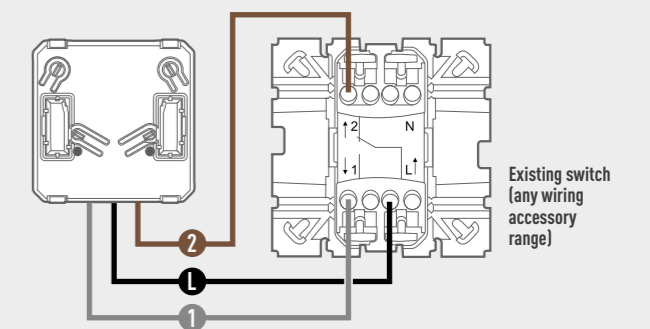

ARTEOR™  
with Netatmo

0 676 94



# ROLLER SHUTTERS

## CONNECTED WIRED SWITCH FOR ROLLER SHUTTER

- For locally and remotely controlling roller shutters from a smartphone with the Home + Control app and using your voice with a voice assistant.

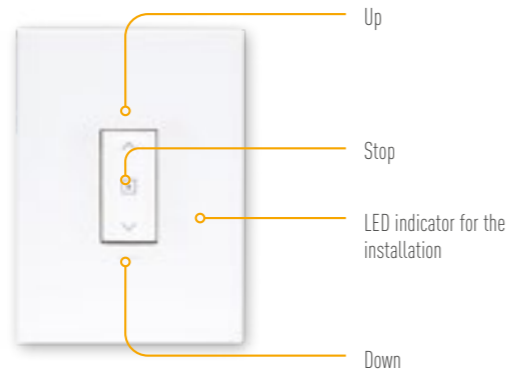

- Fully raise or lower the shutter: quick press
- Adjust shutter height: press and hold then release

**INSTALLATION**  
Box depth 40 mm

**SHUTTERS**  
For all types of wired shutter motor with electronic or mechanical stop

**RETROFIT**  
Can replace an existing switch

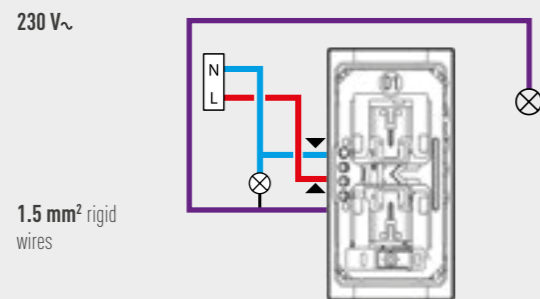

ARTEOR™  
WITH Netatmo

Living Now  
WITH Netatmo

●	●	●	●	●	●
White	Magnesium	Champagne	Aluminium	White	Black
AWNBLIWE	AWNBLIMGN	AWNBLICHP	AWNBLIALU	K4027C+KW32*	K4027C+KG32*

\*To be completed with support frame and coverplate. Refer p.40-43 for more information.



# ROLLER SHUTTERS (continued)

## CONNECTED MICROMODULE FOR ROLLER SHUTTER

- For making an electric shutter connected without wiring, to be able to control it locally from wireless switches, remotely from a smartphone with the Home + Control app and using your voice with a voice assistant.

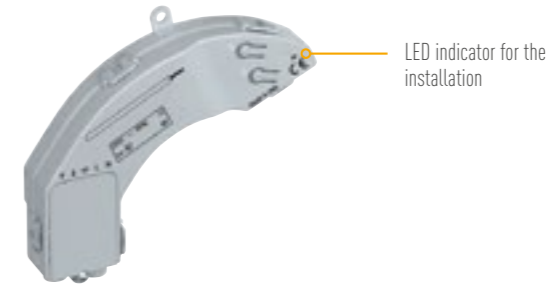

**INSTALLATION**  
In the roof space or the existing shutter head rail

**IP44**  
For locations exposed to humidity

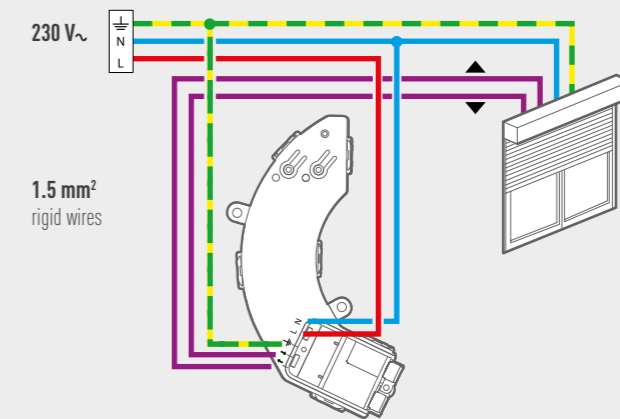

ARTEOR™  
WITH Netatmo

0 676 97



# ROLLER SHUTTERS (continued)

## ACTUATOR AND BUS/SCS CONTROL FOR ROLLER SHUTTERS

- For controlling roller shutters remotely via a 2-wire switch or a smartphone with the Home + Control app and using your voice with a voice assistant. Motors controlled by interlocking relays or by sending pulses Position status feedback: closed, open, intermediate position Controlled according to different commands: up, down or % opening
- Functions:
  - stop, up, down
  - return to an open/closed level which was previously memorised
  - recording of an open/closed level by self-learning directly on the control
- Slats can be tilted up or down

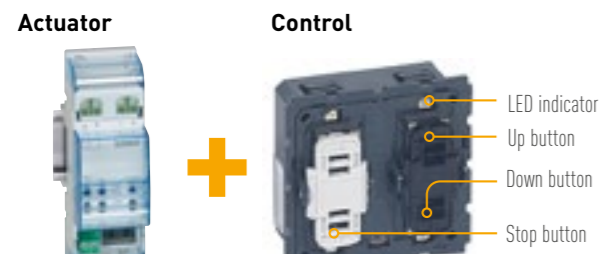

**INSTALLATION**  
Electrical panel Width: 2 x 17.5 mm modules

**BUS terminal block**  
Easily wired up with 2 wires

**INSTALLATION**  
Box depth 40 mm

- Simple parameter setting via the Home + Project app

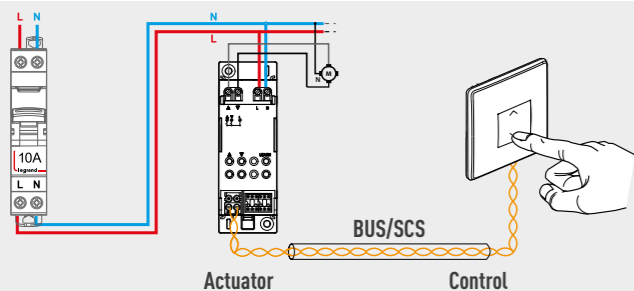

ARTEOR™ My Home	Living Now Digital Controls	
	White	Black
0 675 58	K8001+ KW8011	KG8011+ K8001

To be fitted with cover plates, support and finishing plate. Refer p.40-43 for more information.

## BUS/SCS CONTROL ACTUATOR FOR ROLLER SHUTTERS

- For controlling roller shutters directly (built-in actuator) or via a smartphone with the Home + Control app and using your voice with a voice assistant.
- Functions:
  - stop, up, down
  - return to an open/closed level which was previously memorised
  - recording of an open/closed level by self-learning directly on the control

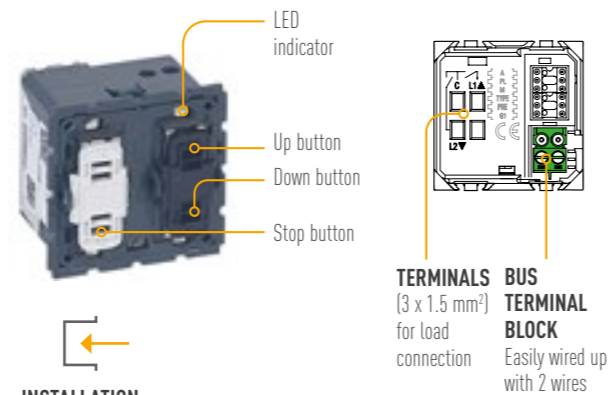

**INSTALLATION**  
Box depth 40 mm

- 1 product to be wired up
- Simple parameter setting via the Home + Project app

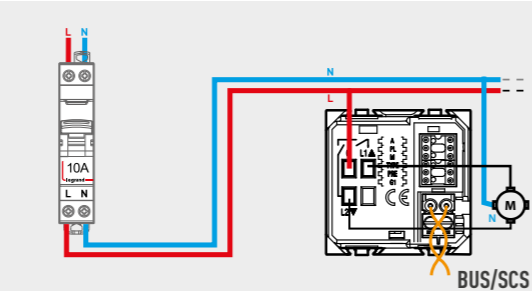

ARTEOR™ My Home	Living Now Digital Controls
0 675 57	

To be fitted with cover plates, support and finishing plate. Refer p.40-43 for more information.

## WIRELESS SWITCH FOR ROLLER SHUTTERS

- For centralising shutter control
- Pair directly in the Home + Control app or by tapping the selected roller shutter switches.

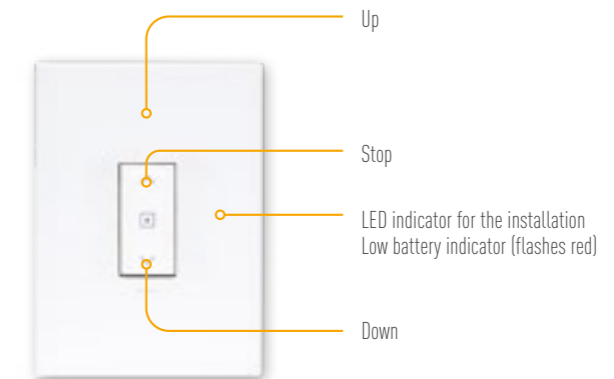

- Fully raise or lower the shutter: quick press
- Adjust shutter height: press and hold then release

**INSTALLATION**  
Attaches to the wall using adhesive pads (supplied). Can be screwed onto a flush-mounting box.

**POWER SUPPLY**  
3 V CR2032 lithium battery (supplied)  
Battery life: 8 years

**LOCATION**  
By a door, on a piece of furniture, etc



EXCEL Life			ARTEOR™ with Netatmo				Living Now with Netatmo	
Gloss White	Matt White	Matt Black	White	Magnesium	Champagne	Aluminium	White	Black
EWNWBLWE	EWNWBLMW	EWNWBLMB	AWNWBLWE	AWNWBLMGN	AWNWBlichP	AWNWBliALU	K4027CW+ KW43M2*	K4027CW+ KG43M2*

\*To be completed with coverplate. Refer p.42-43 for more information.



# ROLLER SHUTTERS (continued)



# FAN CONTROLLER

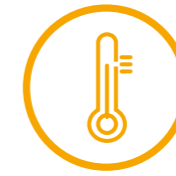

# HEATING

## WIRELESS SWITCH FOR ROLLER/SHUTTERS - CLIP-IN VERSION

- For centralising shutter control
- Pair directly in the Home + Control app or by tapping the selected roller/shutter switch.

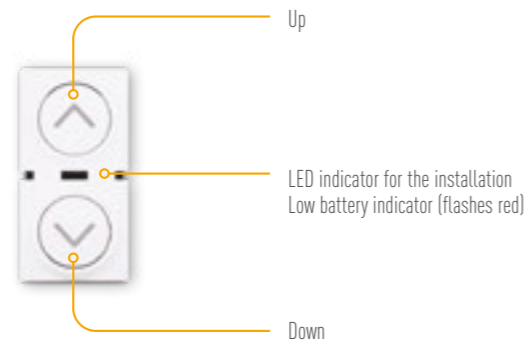

- Fully raise or lower the shutter: quick press
- Adjust shutter height: press and hold then release

**POWER SUPPLY**  
3 V CR2032 lithium battery (supplied)  
Battery life: 8 years

**LOCATION**  
Clipped into grid.

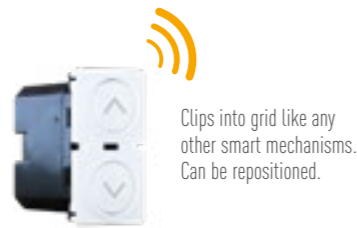

ARTEOR™  
with Netatmo

Living Now  
with Netatmo

EWNWCBLWE	EWNWCBLMW	EWNWCBLMB	574274	574295	574329	574299	K4027CWI+KW01	K4027CWI+KG01

To be completed with grid and coverplate. Refer p.40-43 for more information.

## SMART FAN CONTROLLER

- 4 Speed with visual indicator.
- Speed Memory.
- Failure memory: in case of power cut, fan is set at speed it was last in.

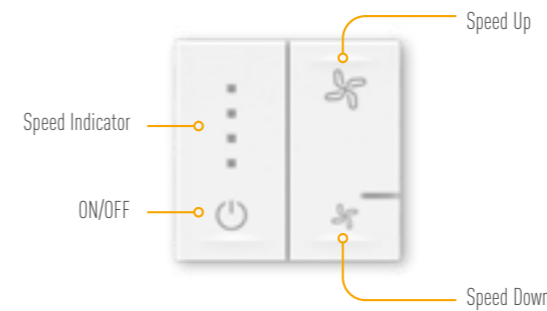

**INSTALLATION**  
Wall mount, depth 40 mm minimum required

**CEILING FAN**  
Compatible with a.c. ceiling fans only

**REFURBISHMENT**  
Can replace an existing fan controller plate

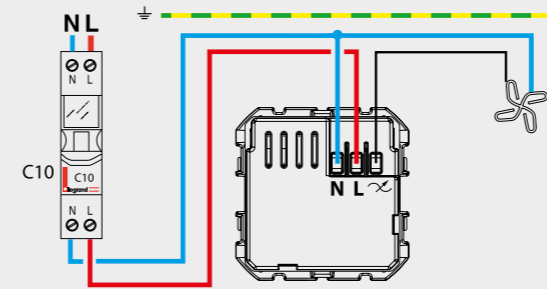

ARTEOR™  
with Netatmo

EWNFCWE	AWNVCWE AWNHCWE	AWNFCMGN AWNHCMGN	AWNVCCHP

## 3000 W CONNECTED CABLE OUTLET

- For controlling a convection heater, radiator, heated towel rail (including pilot wire) remotely from a smartphone with the Home + Control app and using your voice with a voice assistant.
- ON/OFF operation.
- Compatible with electric heaters with a 4 or 6-command pilot wire.
- Protects the circuit against overloads.
- Can be used to monitor power consumption.

### FUNCTIONS FOR COMBINING COMFORT AND ENERGY SAVING

- **Schedules:** in the Home + Control app, for creating schedules based on default and customised temperature settings: Comfort, Comfort+, Night, Eco, Pers
- **Consumption:** measures instantaneous power consumption and tracks daily and monthly power consumption



**INSTALLATION**  
1-gang box, depth 40 mm

**ELECTRIC HEATING**  
For convection heater, radiator, heated towel rail, etc. 3000 W max. 3000 W max.

**RETROFIT**  
Can replace an existing cable outlet

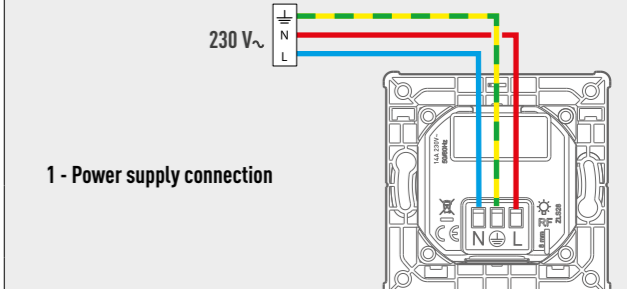

ARTEOR™  
with Netatmo

0 648 79  
Supplied complete with cover plate, support and finishing plate.



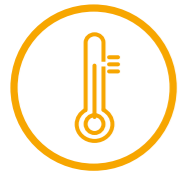

## HEATING (continued)

### BUS/SCS ACTUATOR AND THERMOSTAT FOR HEATING

- For controlling loads such as motorised valves, pumps, fan coil units and electric heaters via a 2-wire thermostat or a smartphone with the Home + Control app and using your voice with a voice assistant.

- In combination with the actuator, used for displaying and controlling the temperature in one area (heating and ventilation speed).

#### Actuator



**BUS TERMINAL BLOCK**  
Easily wired up with 2 wires



**INSTALLATION**  
Electrical panel

#### Thermostat

Backlit screen

FAN COIL UNIT fan operating in automatic mode indicator

Thermostat OFF indicator  
Window indicator: local contact active depending on programming done by installer

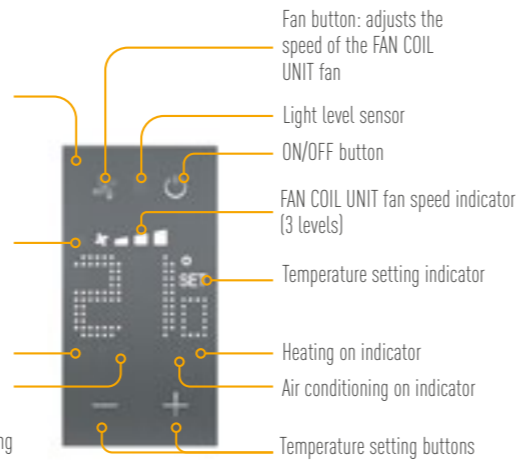

Fan button: adjusts the speed of the FAN COIL UNIT fan

Light level sensor

ON/OFF button

FAN COIL UNIT fan speed indicator (3 levels)

Temperature setting indicator

Heating on indicator

Air conditioning on indicator

Temperature setting buttons



**INSTALLATION**  
Box depth 40 mm

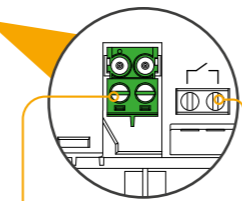

**BUS TERMINAL BLOCK**  
Easily wired up with 2 wires  
Contact with 1 input f or window contact

- Simple parameter setting via the Home + Project app

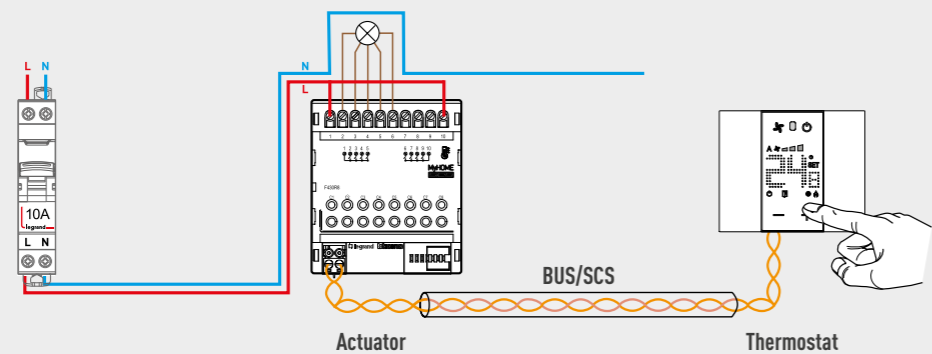

Cat. No.	Type	Loads
F430/2	2 ON/OFF relays	6A resistive 2A motorised valves and pumps
F430/4	4 ON/OFF relays	4A resistive 1A motorised valves, pumps and fan coil unit
F430R8	8 ON/OFF relays	4A resistive 1A motorised solenoid valves, pumps and fan coil unit
F430R3V10	3 ON/OFF relays + 2 x 0-10 V outputs	4A resistive Fan coil unit

**ARTEOR™**  
My Home

Living Now  
Digital Controls

0 674 59\*

White

Matt black

KW4691\*

KG4691\*

\*To be fitted with support frame and finishing plate. Refer p.40-43 for more information.



## ELECTRICAL APPLIANCES

### 20A CONNECTED CONTACTOR

- For controlling a water heater, automatic watering system, swimming pool pump, an electric vehicle socket etc, remotely from a smartphone with the Home + Control app and using your voice with a voice assistant.
- ON/OFF operation (C1 input not prewired): for scheduling appliance operation times.
- Peak/off-peak operation (with CIS (customer information system) input): for controlling a water heater automatically or in override mode.
- Can be used to measure and monitor power consumption.



**INSTALLATION**  
Electrical panel.  
Width: 1 x 17.5 mm module



Electrical appliances up to 4800 W



**USE**  
Motors up to 2400 VA



EV chargers up to 20A

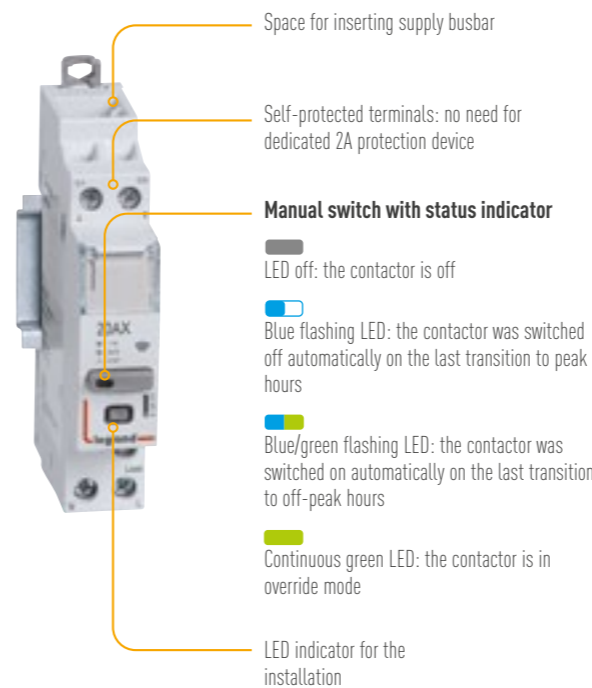

Space for inserting supply busbar

Self-protected terminals: no need for dedicated 2A protection device

#### Manual switch with status indicator

LED off: the contactor is off

Blue flashing LED: the contactor was switched off automatically on the last transition to peak hours

Blue/green flashing LED: the contactor was switched on automatically on the last transition to off-peak hours

Continuous green LED: the contactor is in override mode

LED indicator for the installation

**CX<sup>3</sup>**  
WITH Netatmo

4 121 71

### CONNECTED DRY CONTACT

- A universal measure, command and status report module to remote control appliances in very low voltage such as; electrical charging point, heating manager device, air-conditioning system and watering system
- For single-phase up to 80A installation
- Remote-control device that allows home automation operation as ON/OFF



**INSTALLATION**  
Electrical panel.  
Width: 1 x 17.5 mm module



Peak/off-peak Scheduling



**USE**  
HVAC control



ELV contact up to 24 V d.c.

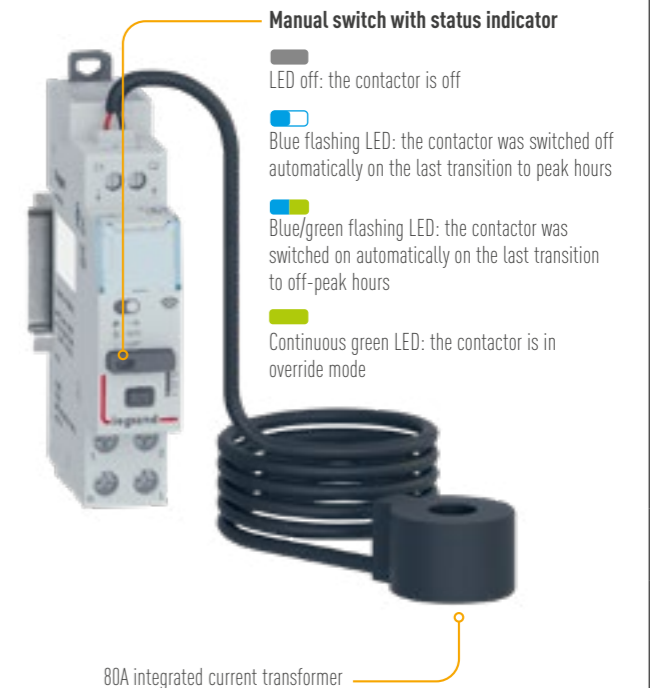

#### Manual switch with status indicator

LED off: the contactor is off

Blue flashing LED: the contactor was switched off automatically on the last transition to peak hours

Blue/green flashing LED: the contactor was switched on automatically on the last transition to off-peak hours

Continuous green LED: the contactor is in override mode

80A integrated current transformer

**CX<sup>3</sup>**  
WITH Netatmo

4 121 73



# ELECTRICAL APPLIANCES (continued)

## 10A CONNECTED POWER OUTLET

- For controlling an electrical appliance remotely from a smartphone with the Home + Control app and using your voice with a voice assistant.
- Can be used to monitor instantaneous and total power consumption (daily and monthly).

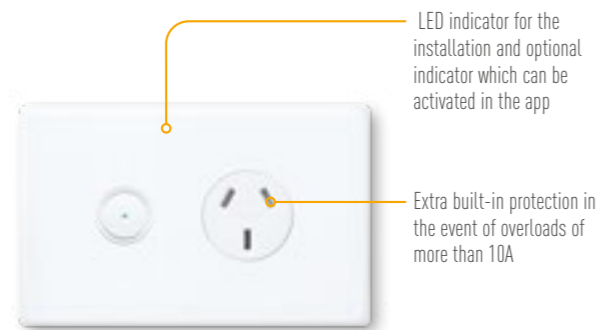

**INSTALLATION**  
Box depth 40 mm  
Screw fixing

**USE**  
All types of electrical appliances and large household appliances

**RETROFIT**  
Can replace an existing socket outlet

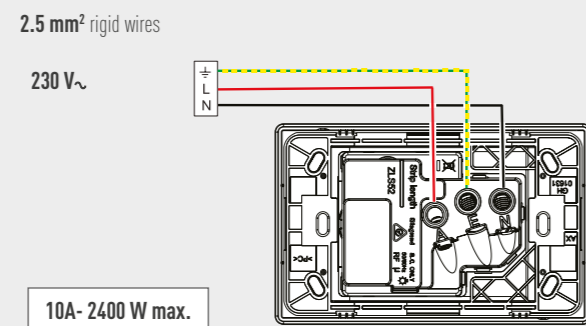

**ARTEOR™**  
WITH Netatmo

**Living Now**  
WITH Netatmo

● White	● Matt White	● Matt Black	● White	● Magnesium	● Champagne	● Aluminium	● White	● Black
EWN787WE	EWN787MW	EWN787MB	AWN787POWE	AWN787POMGN	AWN787POCHP	AWN787POALU	LVNM787A+ K4531C+KW67+KW31*	LVNM787A+ K4531C+KG67+KG31*

\*To be completed with coverplate and support frame. Refer p.42-43 for more information.

## 10A WEATHERPROOF CONNECTED POWER OUTLET

- For controlling an electrical appliance remotely from a smartphone with the Home + Control app and using your voice with a voice assistant.
- Can be used to monitor instantaneous and total power consumption (daily and monthly).
- Flush or surface-mounting.

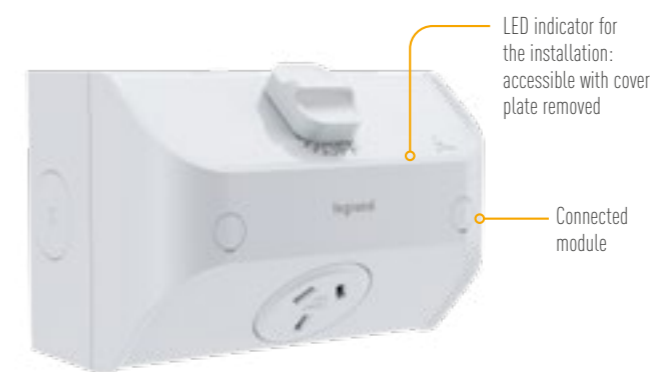

**IP55**  
For outdoors, cellar, basement, garage, laundry room

**INSTALLATION**  
2-gang box, depth 40 mm or 2-gang surface-mounting box  
Screw fixing

**USE**  
All types of electrical appliances and large household appliances

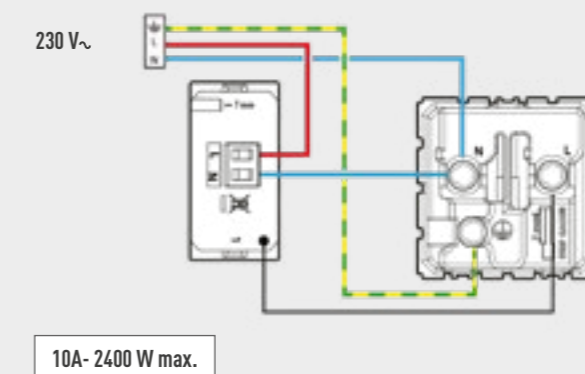

**AQUA Life**  
WITH Netatmo

● Light Grey	● Cement Grey
WL78710TLG	WL78710TCG

## HOME/AWAY WIRELESS MASTER SWITCH

- For making use of predefined scenarios, e.g. the Away scenario, which turns off all the lights when you go out.
- Scenarios can be personalised from the Home + Control app and can combine lighting, shutters, power outlets.

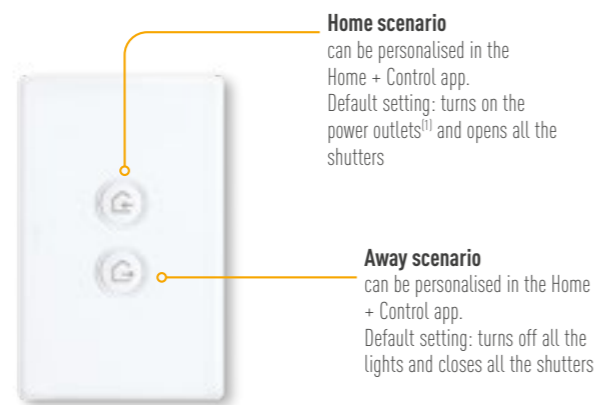

**INSTALLATION**  
Attaches to the wall using adhesive pads (supplied).  
Can be screwed onto a flush-mounting box



**POWER SUPPLY**  
3 V CR2032 lithium battery (supplied)  
Battery life: 8 years



**LOCATION**  
Near the entrance to control the Home and Away scenarios



Extra-slim, attaches to the wall using the adhesive pads provided.  
Can be repositioned.  
Can also be attached to a piece of furniture.



Option to add a Home/Away wireless master switch near another entrance: the scenarios will be identical to those on the main switch



ARTEOR™  
with Netatmo

Living Now  
with Netatmo

White	Matt White	Matt Black	White	Magnesium	Champagne	Aluminium	White	Black
EWNWMSWE	EWNWMSMW	EWNWMSMB	AWNWMSWE	AWNWMSMGN	AWNWMSCHP	AWNWMSALU	K4570CW+KW40M2*	K4570CW+KG40M2*

\*To be completed with coverplate. Refer p.42-43 for more information.

## HOME/AWAY WIRELESS MASTER SWITCH - CLIP-IN VERSION

- For making use of predefined scenarios, e.g. the Away scenario, which turns off all the lights when you go out.
- Scenarios can be personalised from the Home + Control app and can combine lighting, shutters, power outlets.

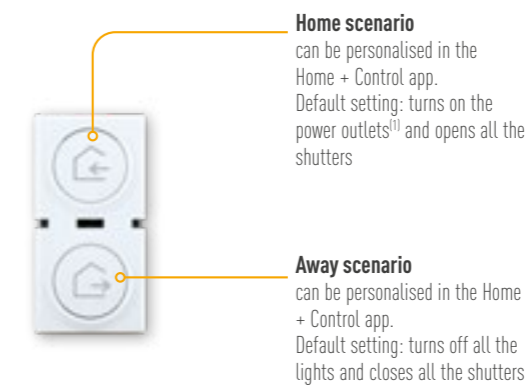

**INSTALLATION**  
Clipped into grid



**POWER SUPPLY**  
3 V CR2032 lithium battery (supplied)  
Battery life: 8 years



Clips into grid like any other smart mechanisms.  
Can be repositioned.



Option to add a Home/Away wireless master switch near another entrance: the scenarios will be identical to those on the main switch



ARTEOR™  
with Netatmo

Living Now  
with Netatmo

White	Matt White	Matt Black	White	Magnesium	Champagne	Aluminium	White	Black
EWNWMSWE	EWNWMSMW	EWNWMSMB	574270	574279	574327	574297	K4570CWI+ KW01	K4570CWI+ KG01

\*To be completed with grid and coverplate. Refer p.40-43 for more information.



## SCENARIOS (continued)

### WAKE UP/SLEEP WIRELESS SWITCH

- For making use of predefined scenarios, e.g. the Sleep scenario, which turns off all the lights and closes all the shutters when you go to bed.
- Scenarios can be personalised from the Home + Control app and can combine lighting, shutters, power outlets.

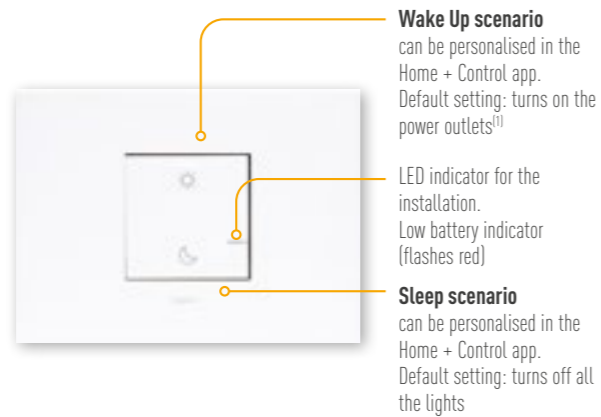

**INSTALLATION**  
Attaches to the wall using adhesive pads (supplied).  
Can be screwed onto a flush-mounting box

**POWER SUPPLY**  
3 V CR2032 lithium battery (supplied)  
Battery life: 8 years

**LOCATION**  
On headboards to control Wake Up/Sleep scenarios

Extra-slim, attaches to the wall using the adhesive pads provided. Can be repositioned.  
Can also be attached to a piece of furniture.

ARTEOR™  
with Netatmo

Living Now  
with Netatmo

White	Magnesium	Champagne	Aluminium	White	Black
AWNNDWE	AWNNDMGN	AWNNDCHP	AWNNDALU	K4574CW + KW41M2*	K4574CW + KG41M2*

\*To be completed with coverplate. Refer p.42-43 for more information.

### WAKEUP/SLEEP WIRELESS SWITCH - CLIP-IN VERSION

- For making use of predefined scenarios, e.g. the Sleep scenario, which turns off all the lights and closes all the shutters when you go to bed.
- Scenarios can be personalised from the Home + Control app and can combine lighting, shutters, power outlets.

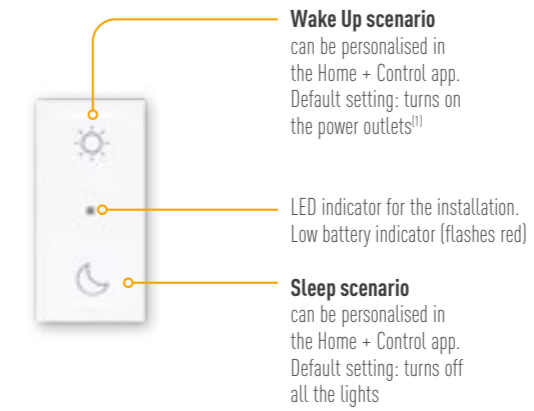

**INSTALLATION**  
Clipped into grid

**POWER SUPPLY**  
3 V CR2032 lithium battery (supplied)  
Battery life: 8 years

Clips into grid like any other smart mechanisms. Can be repositioned.

ARTEOR™  
with Netatmo

White	Magnesium	Champagne	Aluminium
574273	574290	574328	574298

To be completed with grid and coverplate. Refer p.40-41 for more information.

# SCENARIOS (continued)

## 4-SCENARIO WIRELESS SWITCH

- For adding 4 scenarios to a connected installation
- Scenarios can be personalised from the Home + Control app and can combine lights, shutters, electrical appliances, ventilation, etc

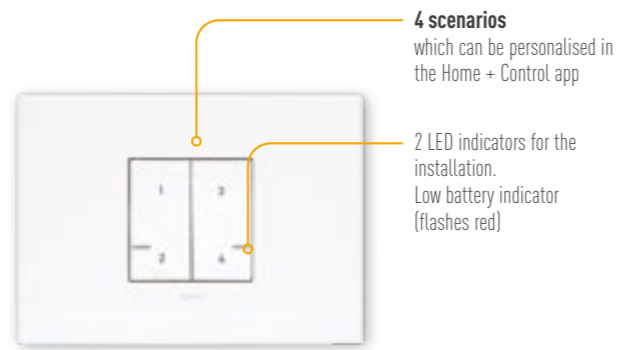

**INSTALLATION**  
Attaches to the wall using adhesive pads (supplied). Can be screwed onto a flush-mounting box

**POWER SUPPLY**  
3 V CR2032 lithium battery (supplied)  
Battery life: 8 years

**LOCATION**  
By a door, on a piece of furniture, etc

Extra-slim, attaches to the wall using the adhesive pads provided. Can be repositioned  
Can also be attached to a piece of furniture

ARTEOR™  
with Netatmo

Living Now  
with Netatmo

White	Magnesium	Champagne	Aluminium	White	Black
574312	574314	574315	574313	K4575CW+KW37M2	K4575CW+KG37M2

To be fitted with coverplate. Refer to p.40-43 for more information.

## 4-SCENARIO POCKET REMOTE CONTROL

- For adding 4 scenarios to a connected installation
- Scenarios can be personalised from the Home + Control app and can combine lights, shutters, electrical appliances, gate, etc

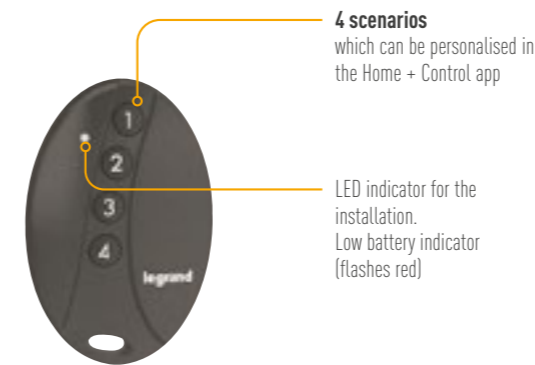

**POWER SUPPLY**  
3 V CR2032 lithium battery (supplied)  
Battery life: 8 years

**LOCATION**  
On a key ring

## BUS/SCS SCENARIO CONTROL

- For launching 4 scenarios (lights, shutters, temperature management, etc)

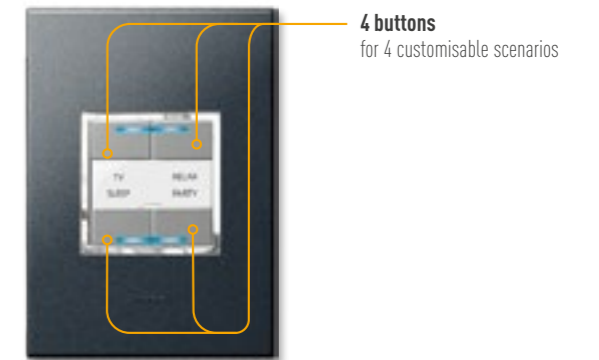

**INSTALLATION**  
1-gang box, depth 40 mm

**BUS TERMINAL BLOCK**  
Easily wired up with 2 wires

- Scenarios configured via the Home + Project app

ARTEOR™  
My Home

White	Magnesium	To be fitted with cover plate
5 745 03	5 745 04	0 675 53

To be fitted with support frame and coverplate. Refer to p.40-41 for more information

**SELECTION CHART**
**83.5mm fixing centres - flush-mounting boxes, support frames and plates**

Number of modules per plate	Flush-mounting boxes	Support frames	Plates	PLATES						PLATES											
				Neutral						Mirror		Brushed Metal			Reflective Metal			Wood	Signature		
				White	Soft Aluminium	Graphite	Magnesium	Champagne	Dark Bronze	Mirror White	Mirror Black	Stainless Steel	Gold Brass	Pink Champagne	Black	Stainless Steel	Black	Gold	Grey Oak	Cube	
<b>SQUARE VERSION - VERTICAL</b>																					
<b>1 vertical module</b>	Standard mounting accessory	5 719 10		5 767 20	5 714 85	5 767 22	5 714 95	5 715 05	5 715 15		5 767 24	5 767 23	5 767 26	5 767 30	5 715 26	5 715 21	5 715 31	5 715 41	5 715 36	5 715 46	5 715 51
<b>2 modules</b>		5 719 10		5 752 50	5 714 82	5 752 52	5 714 92	5 715 02	5 715 12		5 752 54	5 752 53	5 752 56	5 764 30	5 714 27	5 714 17	5 714 37	5 714 57	5 714 47	5 714 67	5 714 77
<b>SQUARE VERSION - HORIZONTAL</b>																					
<b>1 module</b>	Standard mounting accessory	5 719 20		5 752 20	5 714 11	5 752 22	5 752 27	5 714 31	5 714 41		5 752 44	5 752 43	5 752 46	5 764 10	5 714 26	5 714 16	5 714 36	5 714 56	5 714 46	5 714 66	5 714 76
<b>2 modules</b>		5 719 20		5 752 30	5 714 12	5 752 32	5 752 37	5 714 32	5 714 42		5 752 54	5 752 53	5 752 56	5 764 30	5 714 27	5 714 17	5 714 37	5 714 57	5 714 47	5 714 67	5 714 77
<b>3 modules</b>		5 719 20		5 750 10	5 714 13	5 750 12	5 750 17	5 714 33	5 714 43		5 752 74	5 752 73	5 752 76	5 764 50	5 714 28	5 714 18	5 714 38	5 714 58	5 714 48	5 714 68	5 714 78
<b>4 modules</b>	0 800 42	5 760 11		5 750 30	5 714 14	5 750 32	5 750 37	5 714 34	5 714 44		5 750 34	5 750 33	5 750 36	5 762 70	5 714 29	5 714 19	5 714 39	5 714 59	5 714 49	5 714 69	-
<b>6 modules</b>	6 890 36	Supplied with support frame		5 753 70	5 713 06	5 753 72	5 713 16	5 713 26	5 713 36		5 753 74	5 753 73	5 753 76	5 763 70	5 713 56	5 713 46	5 713 66	5 713 86	5 713 76	5 713 96	5 714 06
<b>8 modules</b>	6 890 38	Supplied with support frame		5 767 00	5 713 08	5 767 02	5 713 18	5 713 28	5 713 38		5 767 04	5 767 03	5 767 06	5 767 10	5 713 58	5 713 48	5 713 68	5 713 88	5 713 78	5 713 98	5 714 08

# Living Now WITH Netatmo

## SELECTION CHART

Number of modules per plate	Flush-mounting boxes	Support frames	PLATES						PLATES						
			Neutral						Mirror		Brushed Metal				
			White	Gold	Moon	Ice	Sky	Pixel	Oak	Black	Space	Steel	Walnut	Night	
<b>SQUARE VERSION - HORIZONTAL</b>															
3 modules/SGPO	429 or 435	K4703AU	KA4803KW	KA4803ZW	KA4803NW	KA4803DW	KA4803DA	KA4803MW		KA4803LM	KA4803KG	KA4803NG	KA4803ZG	KA4803LG	KA4803DG
4 modules	PB504N	K4704	KA4804KW	KA4804ZW	KA4804NW	KA4804DW	KA4804DA	KA4804MW		KA4804LM	KA4804KG	KA4804NG	KA4804ZG	KA4804LG	KA4804DG
6 modules	PB508N	K4706	KA4806KW	KA4806ZW	KA4806NW	KA4806DW	KA4806DA	KA4806MW		KA4806LM	KA4806KG	KA4806NG	KA4806ZG	KA4806LG	KA4806DG
Wireless Switches		Not required	KA4802KW	KA4802ZW	KA4802NW	KA4802DW	KA4802DA	KA4802MW		KA4802LM	KA4802KG	KA4802NG	KA4802ZG	KA4802LG	KA4802DG

### Living Now supports

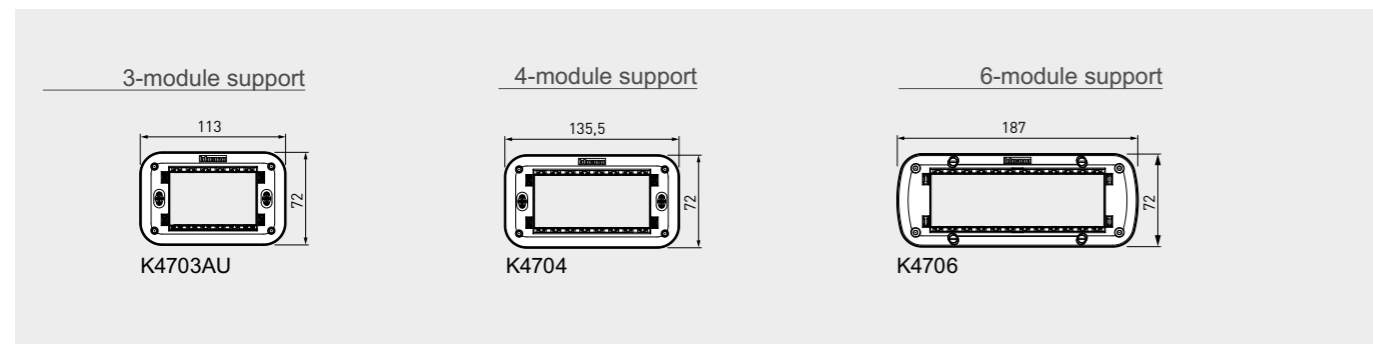

### Living Now cover plates

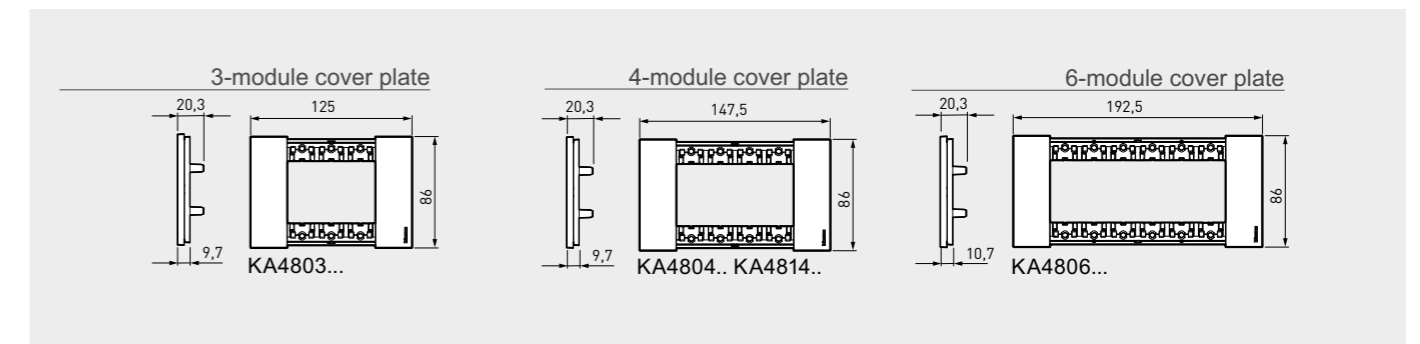

**Notes:**  
Think about filling in any gaps in the support frame with a blank module (K4950) and key cover (KW00 if White, or KG00 if Black)



# GREETING PEOPLE

## CONNECTED AUDIO/VIDEO DOOR ENTRY SYSTEM

- For receiving calls from visitors on the indoor panel and on a smartphone to see who is at the door and speak to them, etc:
  - via the Home + Security app for the Classe 300EOS door entry phone
  - via the Classe 100X Door Entry<sup>(1)</sup> app for the Classe 100X door entry phone.
- Call the indoor panel from a smartphone.
- Open door or gate remotely: unlock electric door release.

- Classe 300EOS with answering machine and visitor log function: visitors can leave a message.
- Classe 300EOS: Security solutions integrated directly in the Home + Security app: indoor and outdoor cameras, door and window opening detectors, sirens, video alarm system. Equipped with Amazon Alexa voice assistant.

### KIT CONTENTS (CAT NO. 364614)

- Connected Classe 100X indoor panel
- 1 Linea 3000 video entrance panel with access control
- 5 key fobs and 2 programmable chips for access control
- 1 master key fob for programming
- 1 x 2-wire BUS power supply with built-in video adaptor
- 1 door release relay for NO/NC volt-free contact (2A max.)

### CLASSE 300EOS INDOOR PANEL

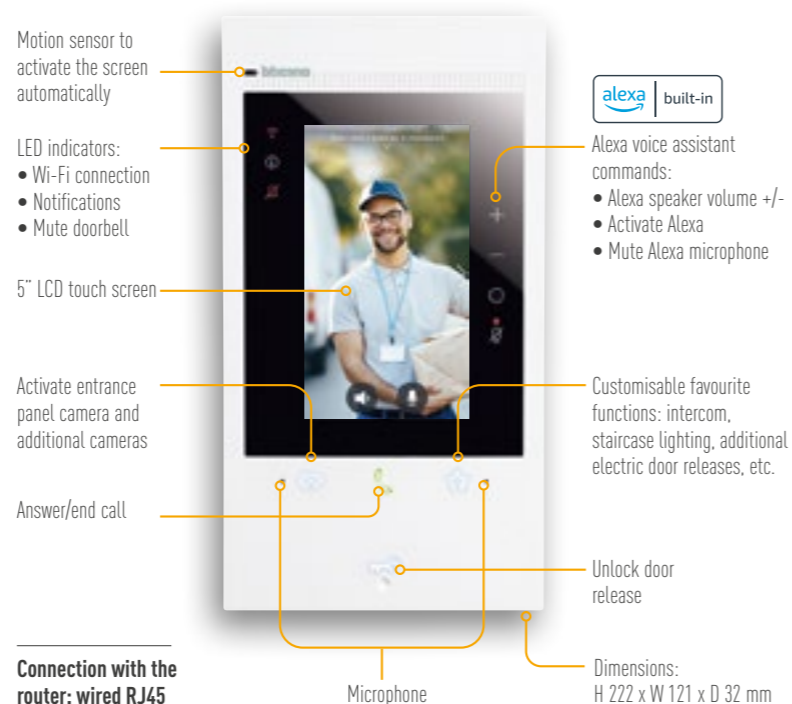

Connection with the router: wired RJ45 or Wi-Fi

### CONNECTED CLASSE 100X INDOOR PANEL

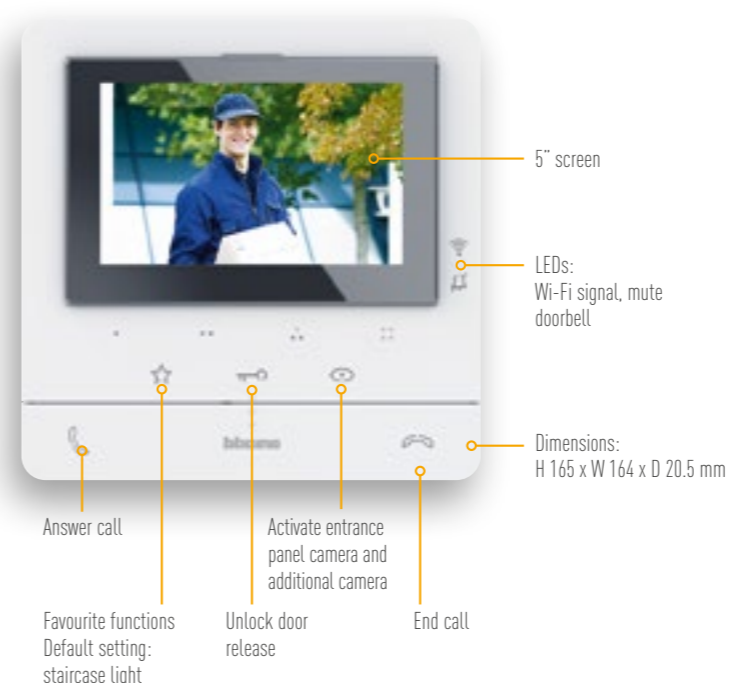

### ENTRANCE PANELS, KEY FOBBS

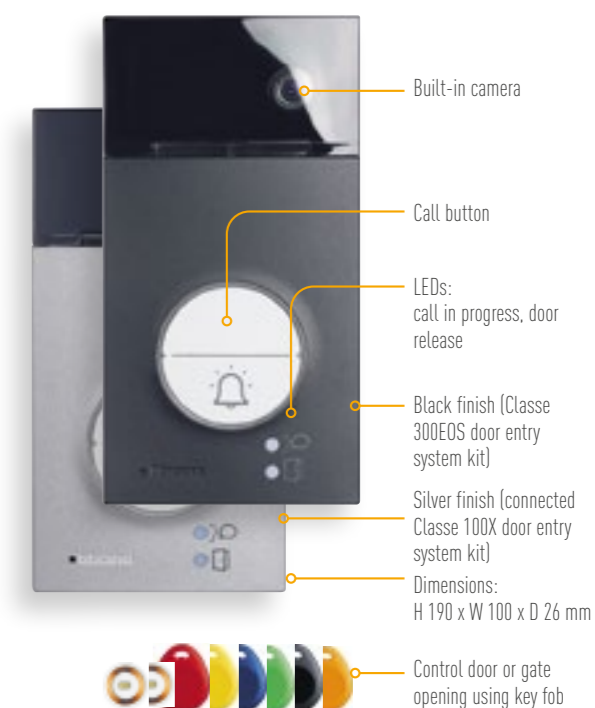

### INSTALLATION DIAGRAM FOR CLASSE 300EOS AUDIO/VIDEO DOOR ENTRY SYSTEM

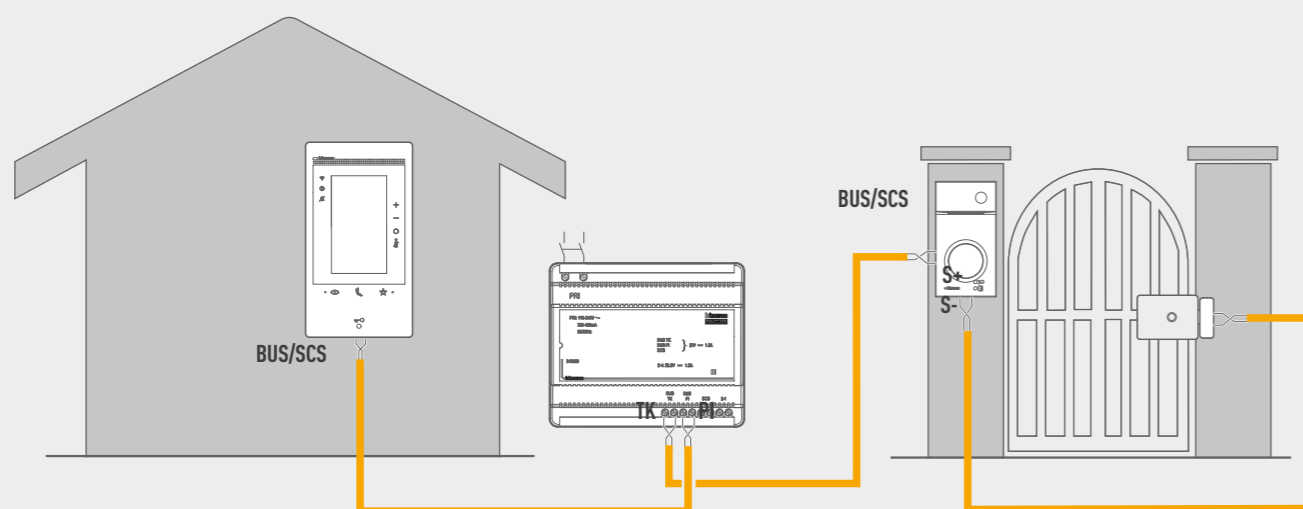

LOCATION OF CLASSE 300EOS INDOOR PANEL  
Near a router



LOCATION OF CLASSE 100X INDOOR PANEL  
Near a router to optimise the Wi-Fi signal



INSTALLATION OF INDOOR PANELS AND ENTRANCE PANELS  
Surface-mounted, flush-mounted cables



INSTALLATION OF POWER SUPPLY  
Electrical panel.  
Width: 6 x 17.5 mm modules

### BUS/SCS POWER SUPPLY

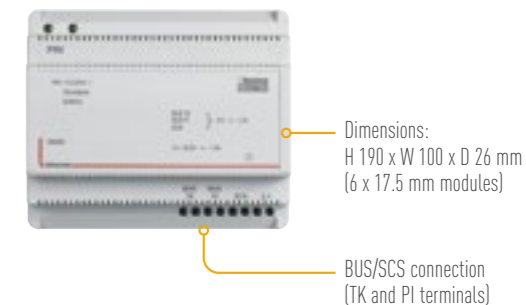

Classe 300EOS audio/video indoor panel



344842

Classe 100X connected audio/video indoor panel



344682

Classe 100X connected audio/video kit



364614

Easy kit connected



318013



## FULL HD SMART INDOOR CAMERA

- For facial recognition: if an unknown face is detected, sends an alert to a smartphone with the Home + Security app (alerts can be personalised in the app).
- Can distinguish between family/friends, strangers and pets.
- Secure video storage, respect for privacy: option to disable video recording of family/friends.

No subscription fees, free updates



Connection with the router: wired RJ45 or Wi-Fi



**LOCATION**

Near a router



**POWER SUPPLY**

Plugs into a socket outlet (mains adaptor included)



**Full protection with the Smart Alarm System with Camera**

### POSITIONING FOR OPTIMAL OPERATION

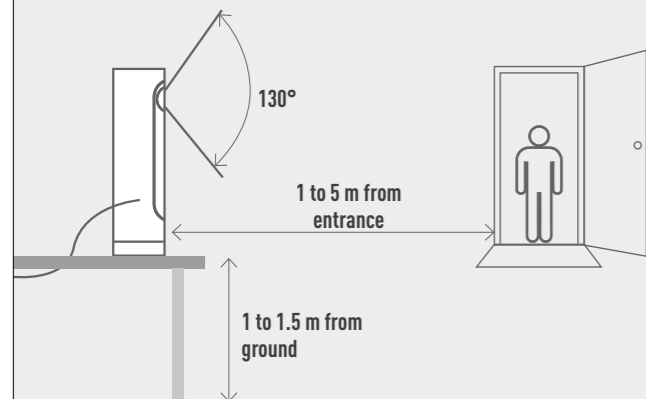

Full HD Smart Indoor Camera

NSC01-P2

## FULL HD SMART OUTDOOR CAMERAS

- If a person or vehicle is detected on the property, send an alert to a smartphone with the Home + Security app (alert zones and types of intrusion can be personalised in the app).
- Can distinguish between people, animals and vehicles.
- Triggers a 105 dB alarm from a smartphone.

No subscription fees, free updates

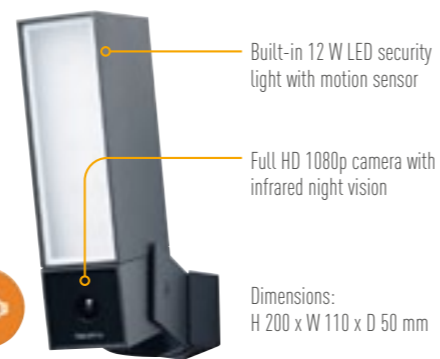

Built-in 105 dB siren



**LOCATION**

Near a router to optimise the Wi-Fi signal



**INSTALLATION**

For replacing an outdoor light (mounting kit included)



**HZO + UV**

Weather resistance + UV protection

### POSITIONING FOR OPTIMAL OPERATION

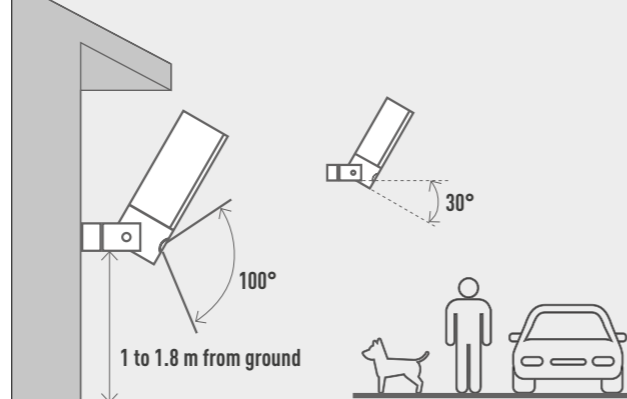

Full HD Smart Outdoor Camera with 105 dB Siren

Black

NOC-S-P

White

NOC-S-W-P

## SMART DOOR AND WINDOW SENSORS

- Detect any movement or vibration that could mean someone is trying to open a door or window and send a notification to a smartphone with the Home + Security app.
- Also send a notification if a window or door is left open.
- Only work with the Smart Indoor Camera.

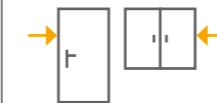

**INSTALLATION**

Attaches to all types of doors and windows using adhesive pads (supplied)



**POWER SUPPLY**

3 x 2 AAA batteries (included)  
Battery life: 8 years



**Full protection with the Smart Alarm System with Camera**

### POSITIONING FOR OPTIMAL OPERATION

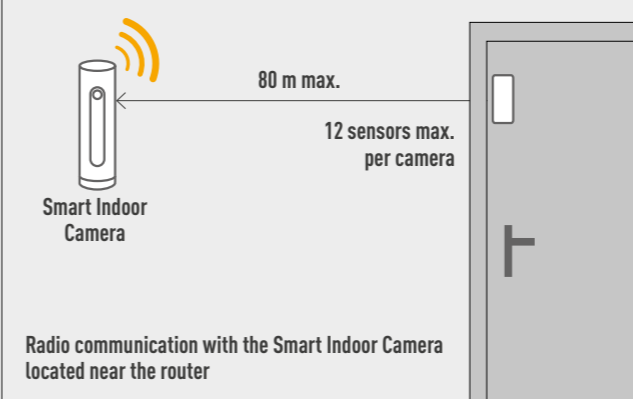

3 Smart Door and Window Sensors

DTG-P

## SMART INDOOR SIREN 110 dB

- Automatically triggers a 110 dB alarm via facial recognition on the Smart Indoor Camera.
- Can be activated remotely from a smartphone with the Home + Security app.
- Presence simulation: pre-recorded household noises (dog barking, children crying, vacuum cleaner, etc).
- Vibration sensors for detecting attempts to disable the siren.
- Only works with the Smart Indoor Camera.

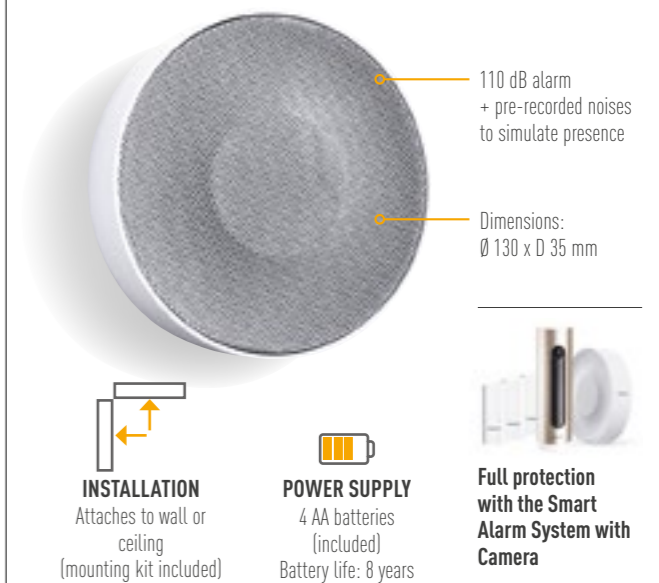

**INSTALLATION**

Attaches to wall or ceiling (mounting kit included)



**POWER SUPPLY**

4 AA batteries (included)  
Battery life: 8 years



**Full protection with the Smart Alarm System with Camera**

### POSITIONING FOR OPTIMAL OPERATION

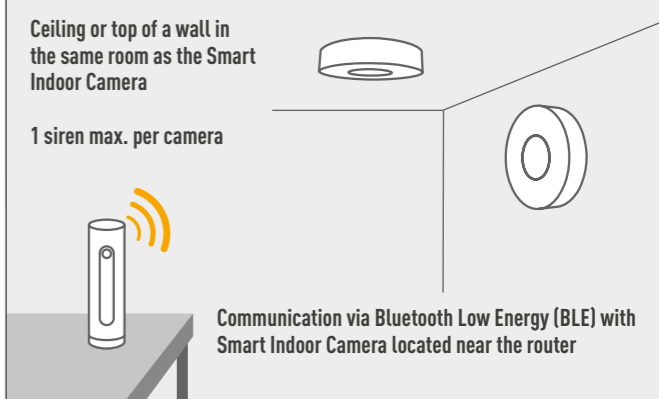

Smart Indoor Siren 110 dB

NIS01-P



# DAY-TO-DAY WELLBEING

## SMART HOME WEATHER STATION

- For accessing different real-time measurements on a smartphone with the Netatmo Weather app: temperature, humidity, air quality, atmospheric pressure, weather, noise level, etc
- Remote access on a smartphone: 7-day weather forecasts, data history.
- Sends notifications if the CO2 level is too high.
- Real-time alerts

SMART HOME WEATHER STATION		ADDITIONAL SMART INDOOR MODULE
MAIN INDOOR MODULE	OUTDOOR MODULE	
<b>Measurements:</b> Indoor temperature Indoor humidity Indoor air quality Sound level meter	<b>Measurements:</b> Outdoor temperature Outdoor humidity Atmospheric pressure Outdoor air quality Weather	<b>Measurements:</b> Indoor temperature Indoor humidity Indoor air quality
 Dimensions: Ø 45 x H 155 mm	 Dimensions: Ø 45 x H 105 mm	 Dimensions: Ø 45 x H 105 mm
<b>LOCATION</b> Near a router to optimise the Wi-Fi signal	<b>POWER SUPPLY</b> Plugs into a socket outlet (micro USB adaptor included)	<b>POWER SUPPLY</b> 4 AAA batteries (included) Battery life: 2 years

### POSITIONING FOR OPTIMAL OPERATION

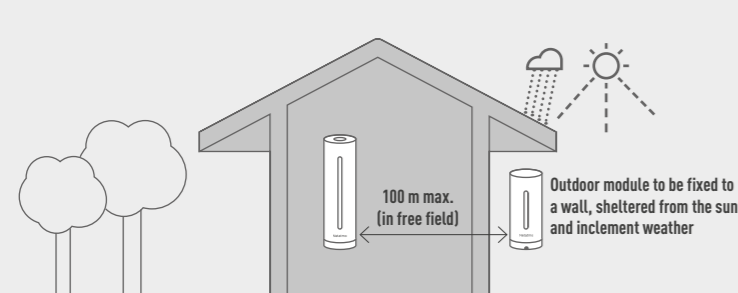

### MEASURING AIR QUALITY ON THE MAIN INDOOR MODULE

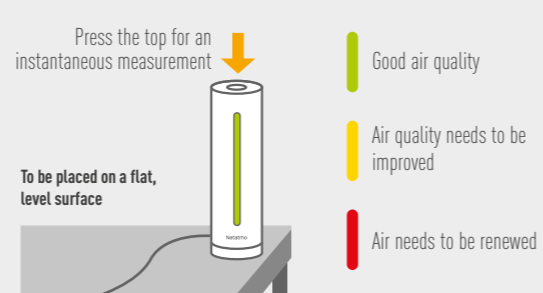

Smart Home Weather Station: 1 main indoor module + 1 outdoor module	Additional Smart Indoor Module
NWS01-P	NIM01-WW

## SMART RAIN GAUGE

- For accessing real-time rainfall measurements on a smartphone with the Netatmo Weather app.
- Displays data history in the form of charts.
- Sends an alert as soon as it starts to rain.

<b>Measurements:</b> Real-time rainfall quantity Daily rainfall quantity	 Dimensions: Ø 130 x H 110 mm
<b>POWER SUPPLY</b> 2 AAA batteries (included) Battery life: 2 years	

### POSITIONING FOR OPTIMAL OPERATION

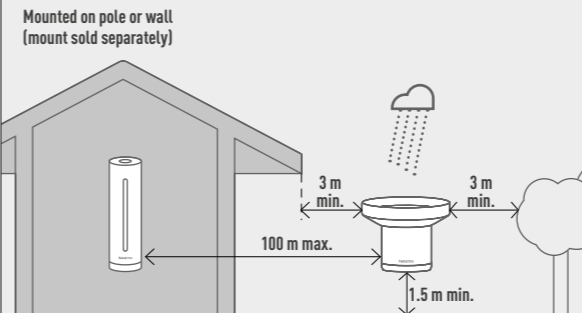

Smart Rain Meter	Mount
NRG01-WW	NWM01-WW

## SMART WIND GAUGE

- For accessing real-time wind speed and direction on a smartphone with the Netatmo Weather app.
- Displays data history in the form of line graphs.
- Sends a custom alert as soon as the wind picks up or reaches a certain speed.

<b>Measurements:</b> Real-time wind speed Real-time wind direction	 Dimensions: Ø 110 x H 85 mm
<b>POWER SUPPLY</b> 4 AAA batteries (included) Battery life: 2 years	

### POSITIONING FOR OPTIMAL OPERATION

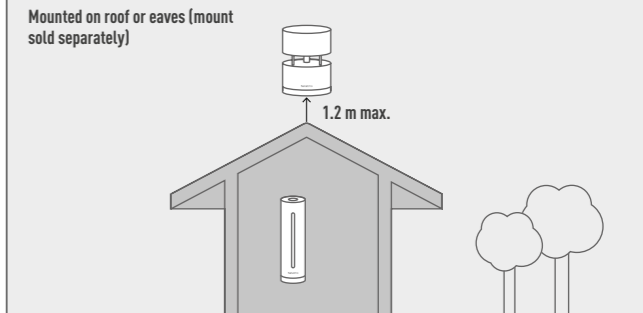

Smart Wind Gauge	Mount
NWA01-WW	NWM01-WW



# GATEWAY FOR INSTALLATION CONNECTIVITY

## STARTER PACK FOR A CONNECTED INSTALLATION, WIRING ACCESSORY VERSION

### GATEWAY

- For controlling the connected installation remotely from a smartphone with the Home + Control app and using your voice with a voice assistant
- Communicates with the router via Wi-Fi and with the rest of the installation via Zigbee radio technology
- Only one gateway is needed per installation. It can control up to 100 wired and wireless products
- The gateway is only sold in the starter kit and cannot be sold separately

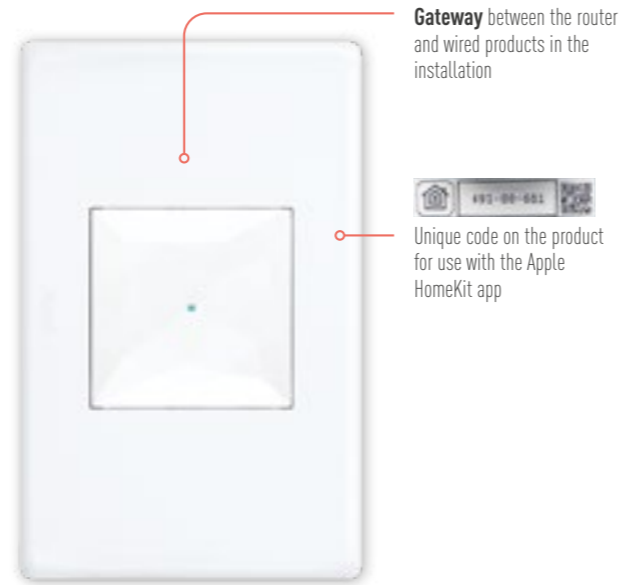

**INSTALLATION**  
Wall mount

**REFURBISHMENT**  
Can replace an existing switch plate (84mm mounting centres)

**LOCATION**  
Near a router to optimise the Wi-Fi signal

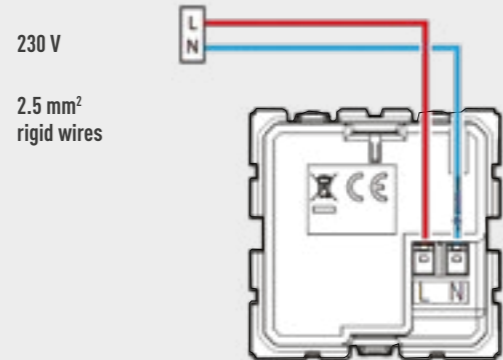

### HOME/AWAY WIRELESS MASTER SWITCH

- For making use of predefined scenarios, such as the Away scenario which turns off all the lights and closes the shutters when you go out.
- Scenarios can be personalised from the Home + Control app and can combine lights, shutters, electrical appliances, ventilation, etc
- Sold in the starter kit and individually, to be added if the home has more than one entrance. Customised life scenarios should be identical on all the master switches.

**INSTALLATION**  
Attaches to the wall using adhesive pads (supplied).  
or screwed to the wall

**POWER SUPPLY**  
3 V CR2032 lithium battery (supplied)  
Battery life: 8 years

**LOCATION**  
Near the entrance to control the Home and Away scenarios

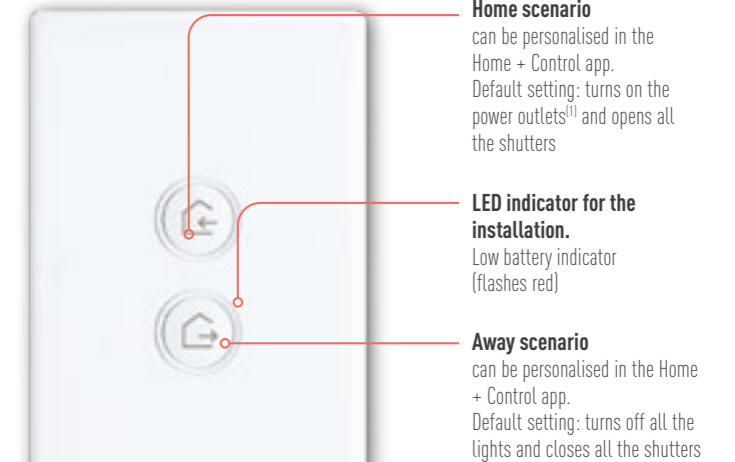

#### Starter pack for a connected installation

White	Matt White	Matt Black	White	Magnesium	Champagne	Aluminium	White	Black
EWNSKITWE	EWNSKITMW	EWNSKITMB	AWNBKITWE	AWNBKITMGN	AWNBKITCHP	AWNBKITALU	K4500C+KW30M2+KW40M2*	K4500C+KG30M2+KG40M2*

\* To be completed with support frame (gateway only) and coverplate. Refer p.42-43 for more information.

#### Additional wireless Home/Away master switch

White	Matt White	Matt Black	White	Magnesium	Champagne	Aluminium	White	Black
EWNWMSWE	EWNWMSMW	EWNWMSMB	AWNWMSWE	AWNWMSMGN	AWNWMSCHP	AWNWMSALU	K4570CW+KW40M2*	K4570CW+KG40M2*

\*To be completed with coverplate. Refer p.42-43 for more information.

(1) Switches on connected power outlets which have previously been switched off (lamp, TV, etc). Some sockets remain on permanently (freezer, router, etc)



# GATEWAY FOR INSTALLATION CONNECTIVITY (continued)

## STARTER PACK FOR A CONNECTED INSTALLATION, MODULAR VERSION

### GATEWAY POWER MODULE

- For controlling the connected installation remotely from a smartphone with the Home + Control app and using your voice with a voice assistant
- Communicates with the router via Wi-Fi and with the rest of the installation via Zigbee radio technology
- One gateway power module (or gateway power outlet, see page 58) is needed per installation. It can control up to 100 wired and wireless products

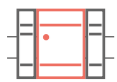
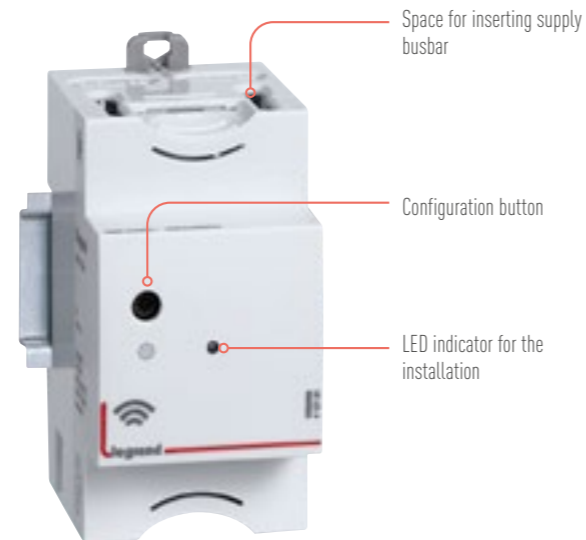

**INSTALLATION**  
Electrical panel.  
Width: 2.5 x 17.5 mm  
modules



**LOCATION**  
Near a router  
to optimise the  
Wi-Fi signal

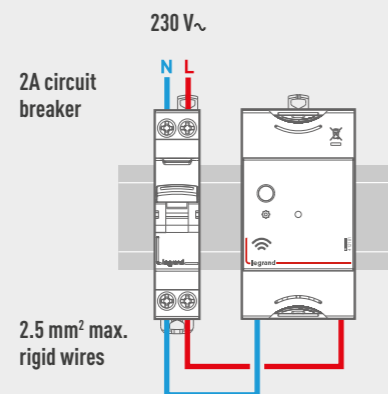

4 121 81

## MyHOME BUS/SCS GATEWAY

- For controlling the BUS/SCS installation remotely from a smartphone or tablet with the Home + Control app
- Automatic detection of connected BUS/SCS devices with an address allocated to every actuator channel
- Only one gateway is needed per installation. It can be connected to a maximum of 175 channels
- Connection to the Ethernet network with RJ45 cable

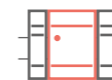
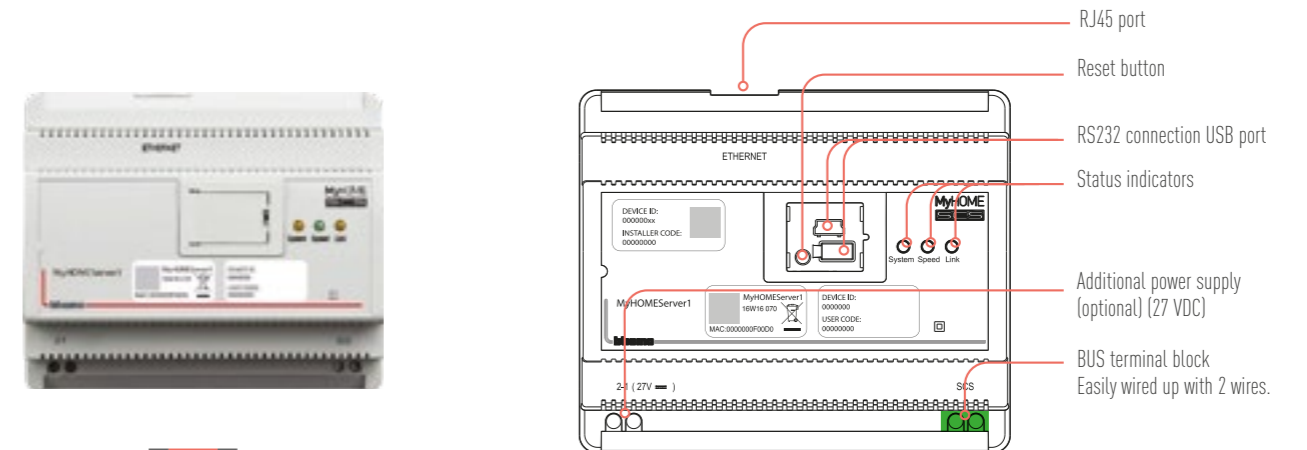

**INSTALLATION**  
Electrical panel  
Width: 6 x 17.5 mm  
modules

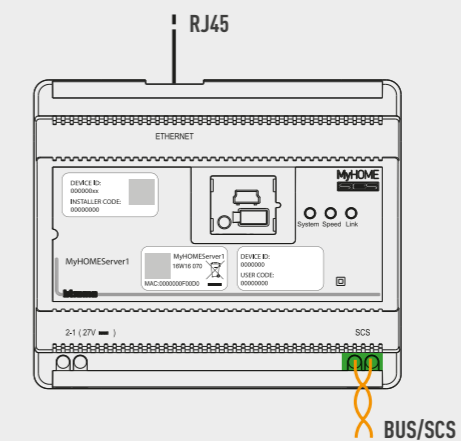

MYHOMESERVER1



# GATEWAY FOR INSTALLATION CONNECTIVITY (continued)

## GATEWAY BUS/SCS INSTALLATION

- For controlling a BUS/SCS installation remotely from a smartphone with the Home + Control and Home + Security apps and using your voice with a voice assistant.
- Built-in Amazon Alexa voice assistant
- Communicates with the router via Wi-Fi
- 2-wire BUS wiring for door entry phone function
- Netatmo security solutions integrated natively and directly in the Home + Security app: indoor and outdoor cameras, door and window opening detectors, sirens, video alarm system.

### CLASSE 300E0S

Presence sensor to activate the screen automatically

LED indicators:  
• Wi-Fi connection  
• Notifications  
• Mute doorbell

5" LCD touch screen

Activate entrance panel camera and additional cameras

Answer/end call

Connection with the router: wired RJ45 or Wi-Fi

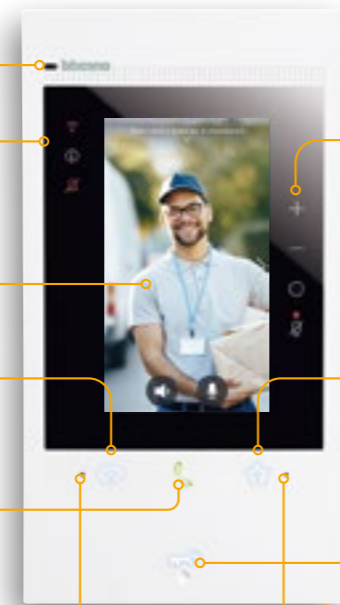

Alexa voice assistant commands:  
• Alexa speaker volume +/-  
• Activate Alexa  
• Mute Alexa microphone

Customisable favourite functions: intercom, staircase lighting, additional electric door releases, etc

Unlock door release

Dimensions: H 222 x W 121 x D 32 mm

Microphone

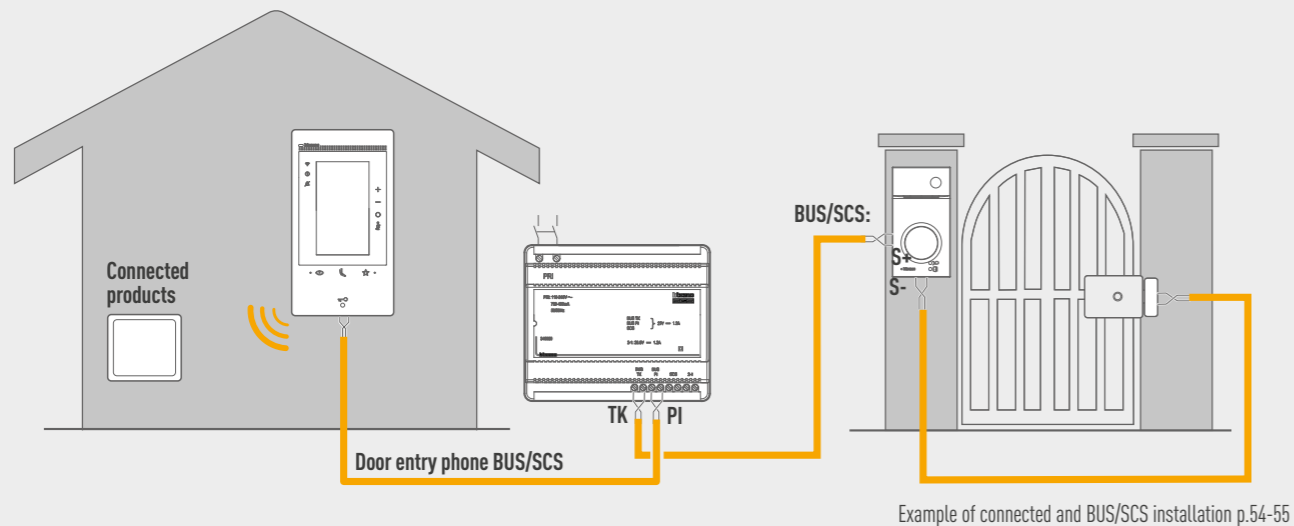

**bticino**

Audio/video indoor panel  
Classe 300E0S

344842



**legrand**



**FOR MORE INFORMATION, GO TO THE LEGRAND WEBSITE**

Find all the information you need for installing "with Netatmo" solutions on our website:

- Installation tutorials
- Technical characteristics
- Instructions and user guides
- FAQs



**POWERPLAN**  
DESIGNING YOUR FUTURE

### TO PRICE UP YOUR QUOTES

Find the "with Netatmo" solutions in **Powerplan** to help prepare your quotes easily.

Learn more about PowerPlan on [Legrand.com.au](http://Legrand.com.au) and get access today by contacting a Legrand representative.  
[powerplan.legrand.com.au](http://powerplan.legrand.com.au)

# INSTALLATION TIPS



## CREATE A TWO-WAY SWITCH FOR NEW OR REFURBISHMENT WORK

**SOLUTION 1**

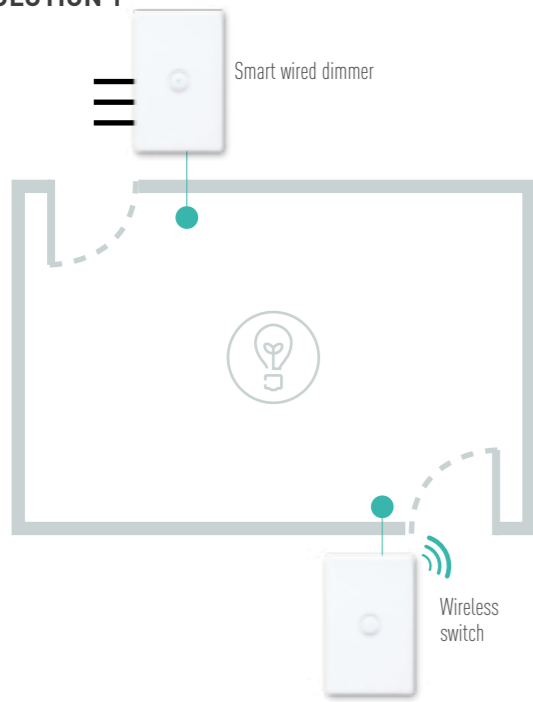

**SOLUTION 2**

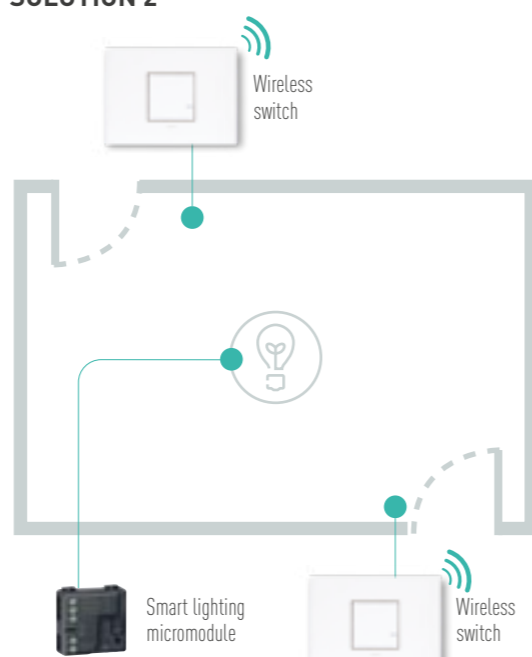

## CREATE SEVERAL CONNECTED SWITCH POINTS

**NEW INSTALLATION**

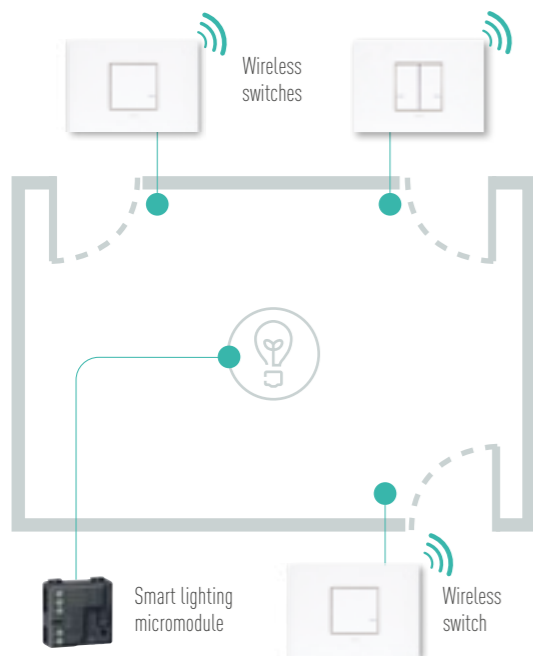

**REFURBISHMENT INSTALLATION  
(replacing a latching relay)**



## CREATING A SWITCHED POWER OUTLET IN A NEW OR REFURBISHMENT INSTALLATION

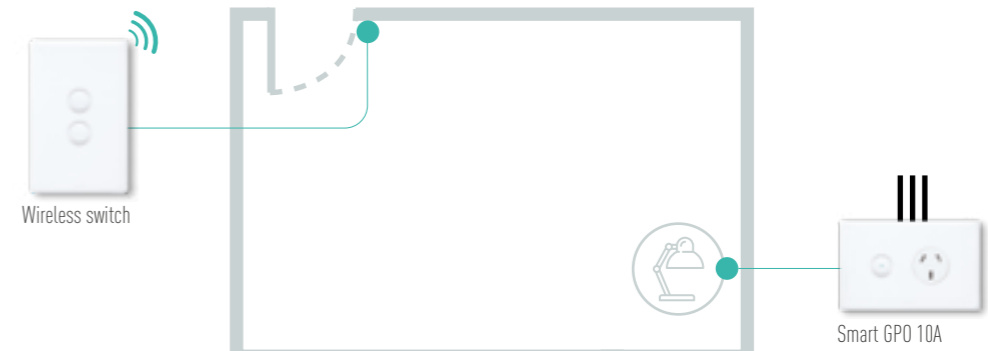

## CENTRALISE ROLLER SHUTTER CONTROL

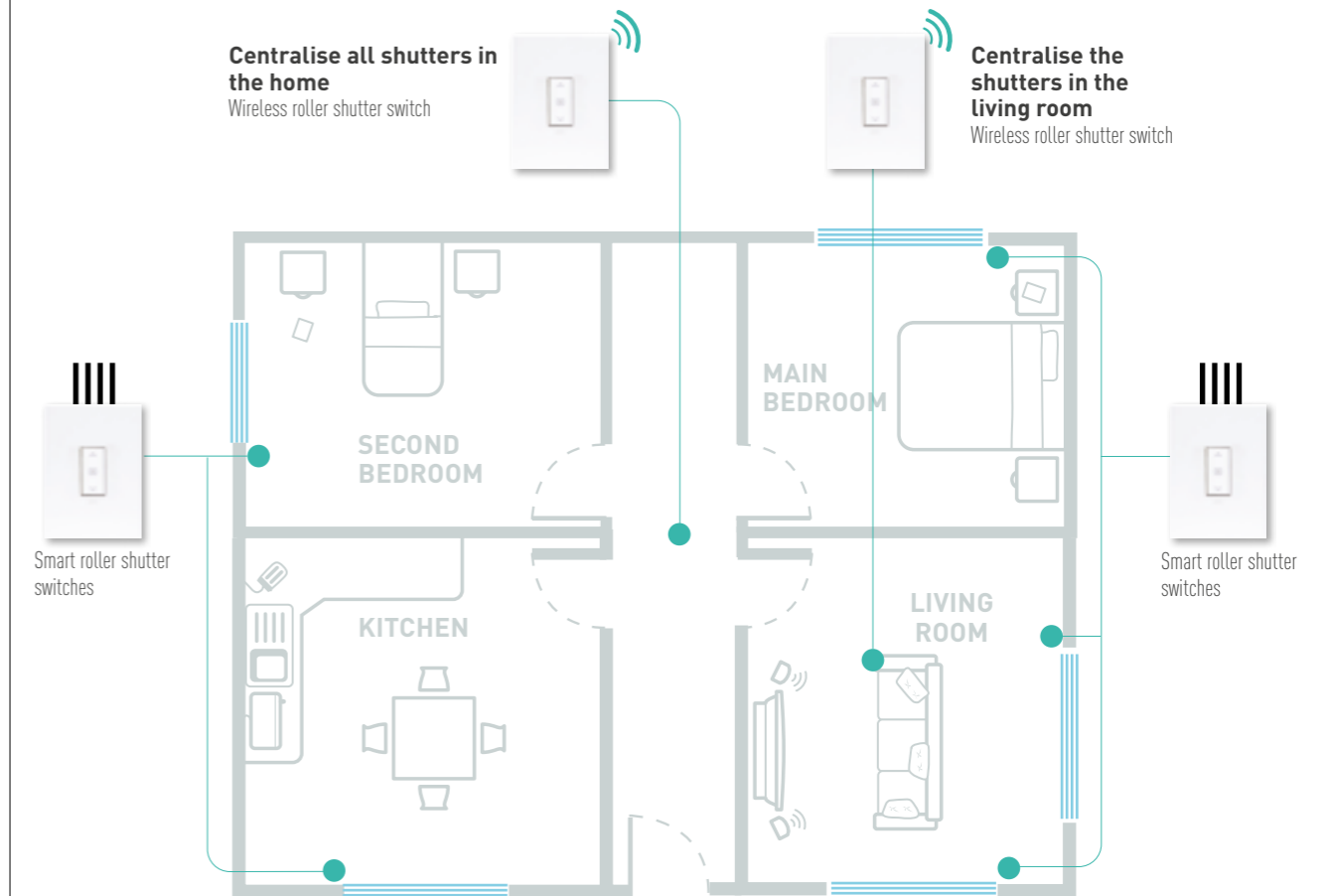

# EXAMPLE OF BUS/SCS AND RADIO ZIGBEE CONNECTED INSTALLATION

**BUS/SCS**  
**ZIGBEE RADIO**

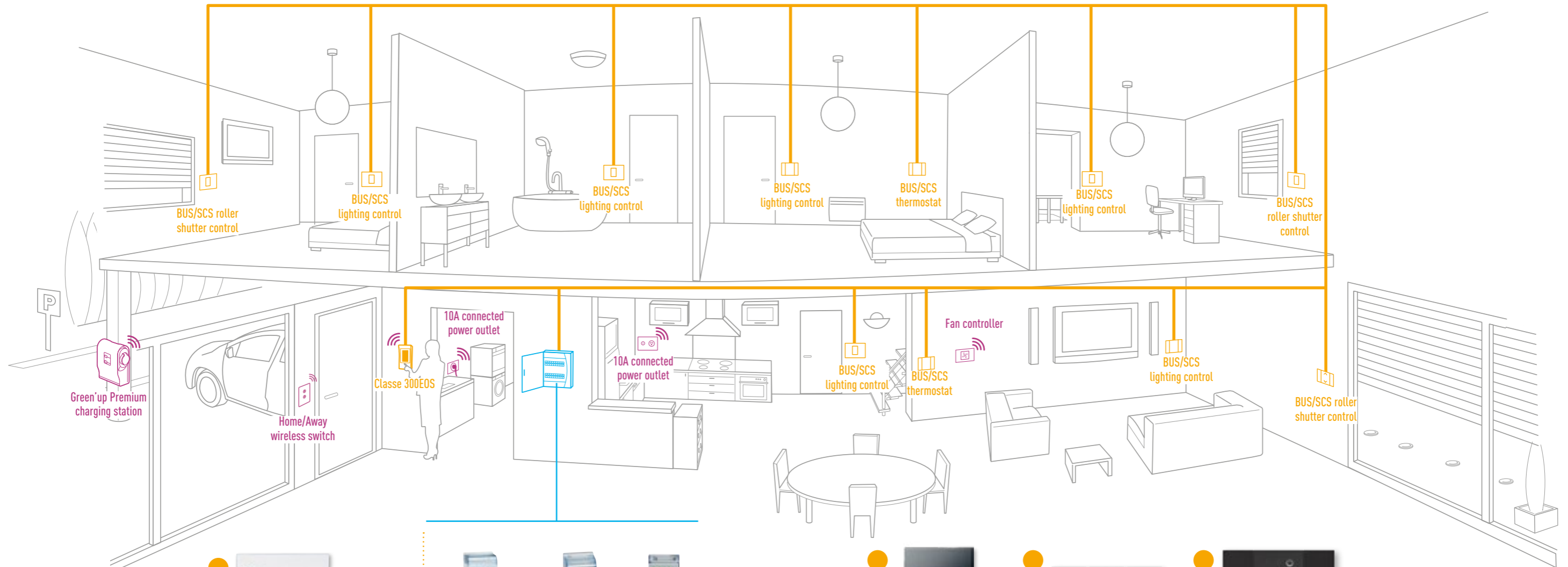

# EXAMPLES OF SCENARIOS AND SCHEDULES

Below are some examples of scenarios and schedules that can be created in the Home + Control app. The installed products control the lights, lamps, electrical appliances, shutters, ventilation system, etc.

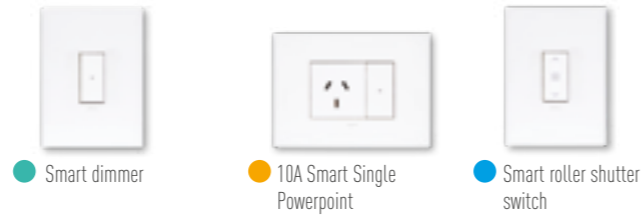

## “AWAY” SCENARIO

### Home/Away wireless master switch located by the entrance

Pressing the bottom of the button activates the scenario, which can be personalised as required in the Home + Control app.

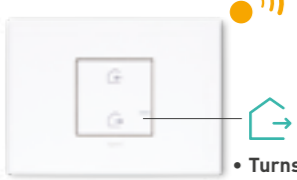
- 
- Turns off all ceiling and wall lights
  - Turns off all table lamps and standard lamps
  - Closes the shutters in the living room

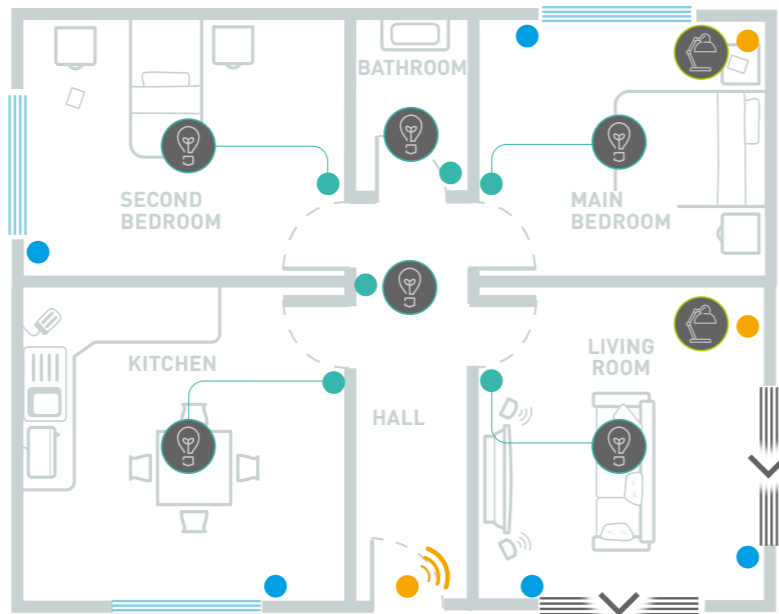

## “HOME” SCENARIO

### Home/Away wireless master switch located by the entrance

Pressing the top of the button activates the scenario, which can be personalised as required in the Home + Control app.

- 
- Turns on the lights in the hall
  - Turns on the lights and standard lamp in the living room
  - Opens the selected shutters

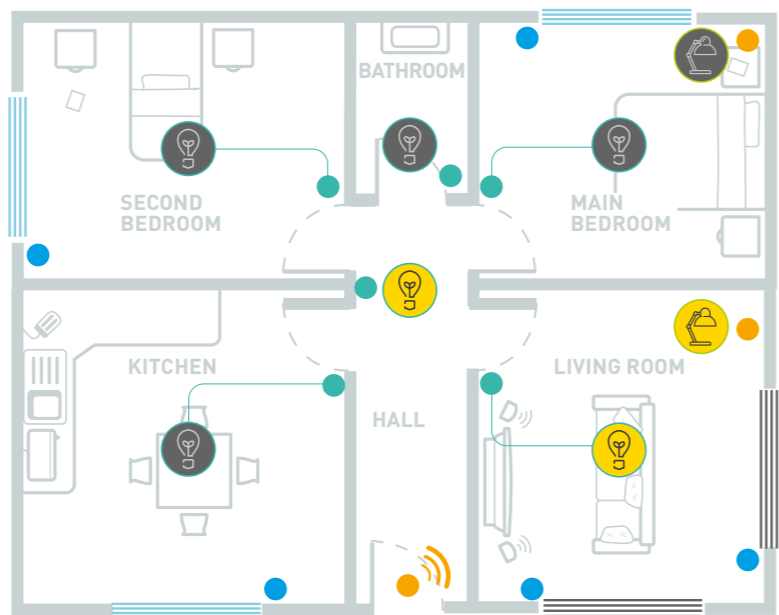

## TEMPERATURE + EVENTS SCHEDULE

- 7 am**
  - House temperature: Comfort mode
  - Open all the shutters
  - Turn on light in main bedroom to 50% setting
  - Bathroom fan: high
- 8 am**
  - Turn off light in main bedroom
  - Bathroom fan: low
- 9 am**
  - House temperature: Eco mode
  - Turn off electric vehicle charging socket
- 6 pm**
  - House temperature: Comfort mode
- 9 pm**
  - Turn on pool pump motor
- 11 pm**
  - Turn on electric vehicle charging socket
  - House temperature: Eco mode
- 6 am**
  - Turn off pool pump motor

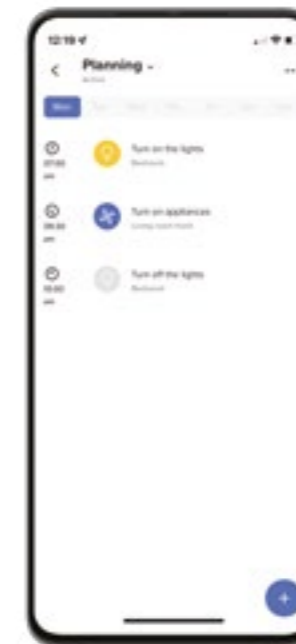

Schedule of everyday actions in the Home + Control app

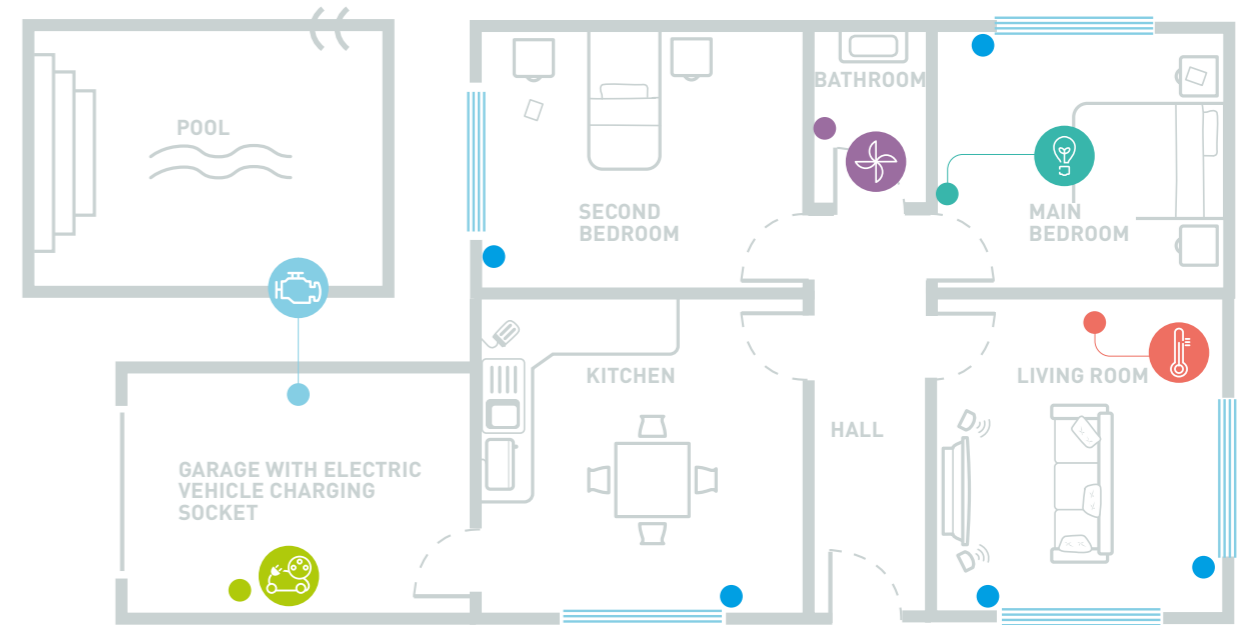



# STARTING CONFIGURATION AND PAIRING WITH THE HOME + CONTROL APP

## CREATE THE NETWORK

After installing and wiring up the wired products, **turn the power back on**. The LEDs on the products **light up with a steady red light**.

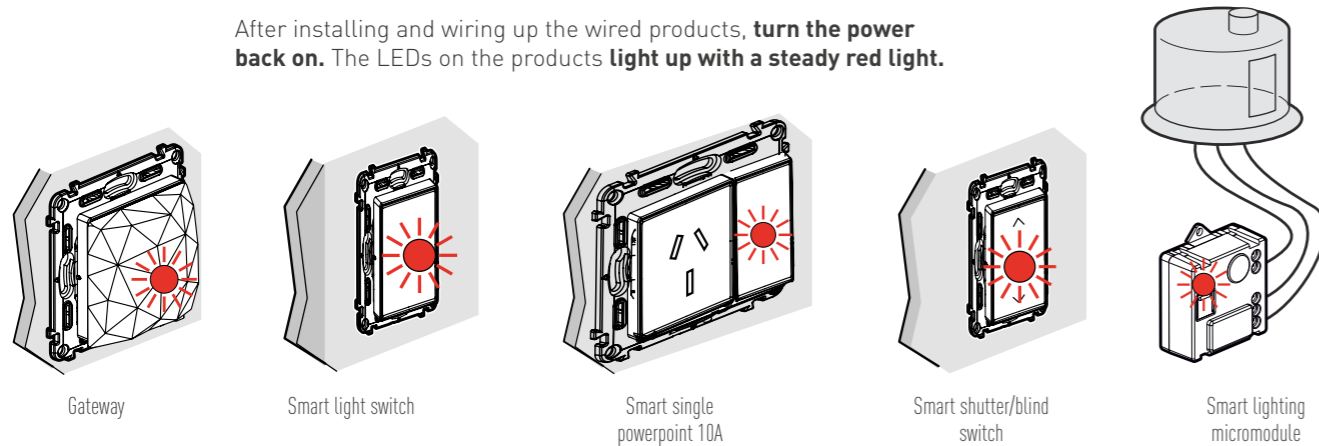

### YOU HAVE INSTALLED A GATEWAY FROM THE STARTER KIT

- 1** Remove the protection tab from the battery to supply power to the **Home/Away wireless master switch**.
- 2** **Press briefly** in the centre of the master switch in order to activate it. **Its LED flashes green** then goes off. **The indicator on the Gateway power outlet also goes off.**
- 3** **1**-Move the master switch close to the Gateway power outlet and press the centre of the switch until its LED briefly lights up green.  
**2**-Release. The LED goes off.  
**3**-The Gateway power outlet LED changes to a **steady green light**.

### YOU HAVE INSTALLED A GATEWAY POWER MODULE

- 
- Press the Gateway power module configuration button** until it flashes, then release. The Gateway power outlet LED changes to a **steady green light**.
- One after another, the LEDs on the other wired products change to a steady green light.
- 
- The network is created.**

## PAIRING WIRELESS SWITCHES

After creating the network, you can pair wireless switches to control the connected switches and power outlets.

Possible combinations of wireless switches and wired products: see page 4.

- 1** Remove the protection tab from the wireless switch you wish to pair, then go to steps 2, 3 and 4. Repeat the same operations with each switch, one after another.
- 2** **Press briefly** on the wireless switch you wish to pair in order to activate it. Its LED **flashes green** then goes off.
- 3** Keep your finger pressed on the top or bottom of the wireless switch, then tap 3 times on the product you wish to control.
- 4** **1**-The LEDs on both products **flash quickly (blue)** then light up briefly (steady blue).  
**2**-The LED on the wireless switch goes off, the one on the wired product reverts to green.  
**They have been paired successfully. Repeat the same operations with each wireless switch, one after another.**

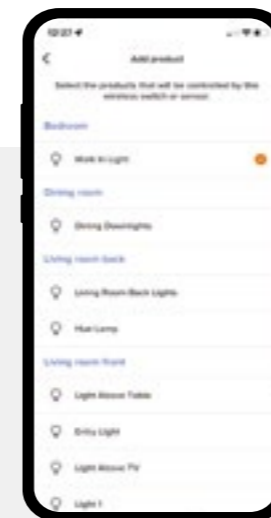

If the wireless switches have not been paired by tapping them on wired products, you can pair them from the Home + Control app.

Go to Settings/Manage my home/Unplaced products, then select the wireless switch you wish to pair.

**IMPORTANT: Batteryless wireless switches can all be paired in both the Home + Control app and by tapping the switches on the selected wired products.**



Once you have finished installation, leave the starter pack user guide with your customer: importantly, it contains the unique code to be scanned in order to use the Apple HomeKit app. Also leave them the manuals for any installed products.

# CONFIGURE THEIR BUS/SCS INSTALLATION WITH HOME + PROJECT

REQUIRES THE CLASSE 300EOS GATEWAY OR THE MYHOMESERVER1 GATEWAY

## A TOOL FOR YOU

- 1 app available in 2 modes to help you do your job:  
Use the WebApp version on your PC and the mobile version on your smartphone
- Save time and easily duplicate your projects with the Copy/Paste function
- Share your projects with your colleagues
- You can connect to the system to configure it on site, even without an internet connection
- Hand over the system to your customer in working order and ready to use
- Back up all your projects

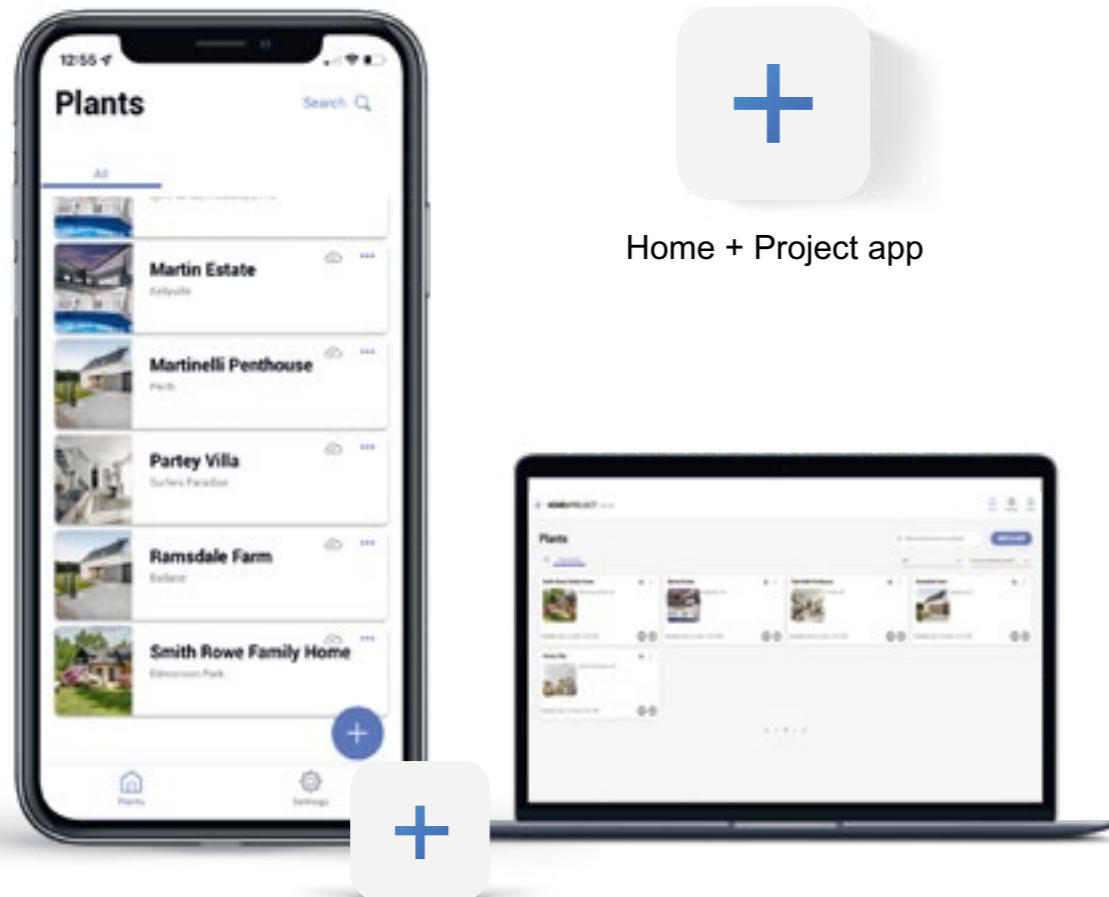

Home + Project app

## 1 DESIGN THE SYSTEM IN THE OFFICE OR DIRECTLY ON SITE: CREATE THE PROJECT WITH THE LIST OF ROOMS AND LIST OF PRODUCTS



### Advantages:

Copy/paste, project archives, personalised tags, detailed view of the project and every room

### DESIGN AND PERSONALISE INSTALLATIONS QUICKLY

Thanks to the "copy/paste" function, there is no point in creating a new programme every time. You can duplicate a similar project and only make the necessary modifications to personalise it. A very useful function which can save you time, especially when designing flats in an apartment block or for an estate of private houses.

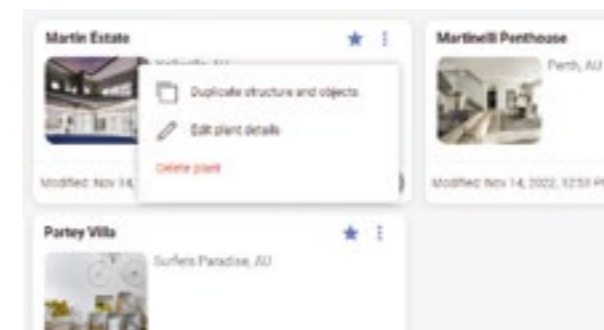

### SEE ALL THE PROJECT INFORMATION AT A GLANCE

On selecting your project, you immediately get an overview of the whole installation: number of rooms, appliances present, server settings, defined scenarios, etc. You can also check the entire project, make changes (add/delete rooms and/or products) and also enter notes and add useful attachments.

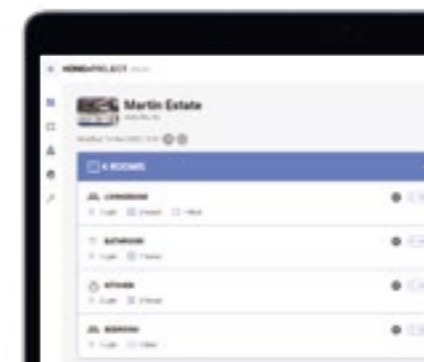

### EASILY GROUP YOUR PROJECTS TOGETHER, MANAGE AND SHARE THEM

You can pair one or more TAGs or key words with each project: for example, by type of building (house, villa or flat), to identify the floor plan of a flat, etc. In this way, you can group similar projects together or only filter those projects and configurations that interest you: **managing your projects has never been so easy!** Moreover, by sharing your projects with your colleagues, you can manage your work even more efficiently.



### DETAILED VIEW OF ALL DEVICES

View and easily change the details of each layout room by room: number of appliances, type, configuration of each installed product.

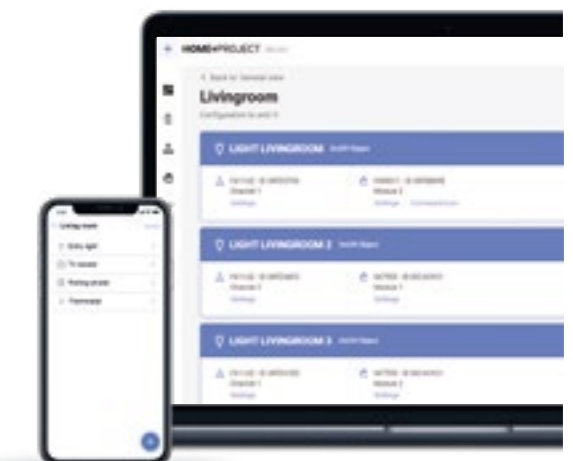

# CONFIGURE THEIR BUS/SCS INSTALLATION WITH HOME + PROJECT (continued)

## 2 ON-SITE CONFIGURATION: CONNECTION TO THE SYSTEM, PAIRING DEVICES AND CREATING SCENARIOS



**Advantages:**

Access to the server even when there is no internet connection, manual or automatic configuration (push&learn function).

**ON-SITE CONFIGURATION WITH THE MOBILE VERSION**

- Select an existing project or create a new project
- Connect the app to the system via the local Wi-Fi generated by the Classe 300EOS or via a mobile access point and launch the system configuration process



- Create a list of rooms and add functions to the system. If you have already created a configuration from your PC with the WebApp version, you will find the rooms and functions already configured and can change them if necessary
- Pair the actuators with the controls



## 3 HANDING THE SYSTEM OVER TO THE CUSTOMER



**Advantages:**

save time by handing over to your customer the system already working on the Home + Control app.

- Once configuration is complete, the system is ready. Your customers simply need to download the Home + Control and Home + Security apps to start managing their house in a smart and simple way!



Home + Control app

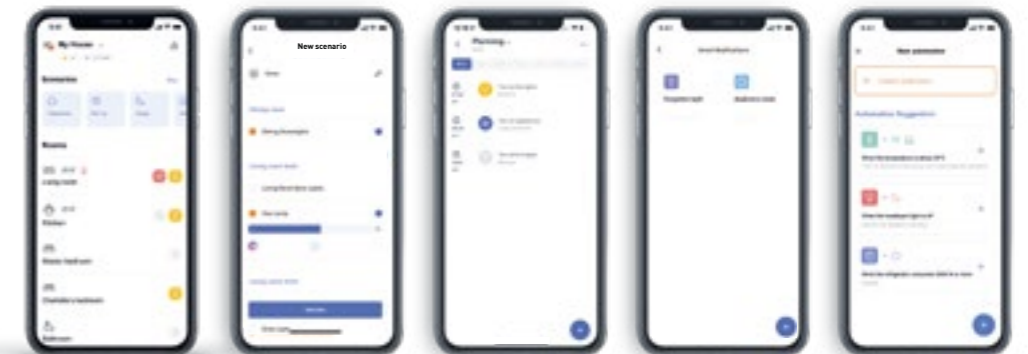

WELCOME SCREEN

SCENARIOS  
50 max.

SCHEDULES  
60 max.

SMART NOTIFICATIONS  
20 max.

AUTOMATION



Home + Security app



WELCOME SCREEN  
OVERVIEW SCREEN

INCOMING CALLS  
Answer video calls at the door even when not at home

REAL-TIME ALERT  
Receive a notification when someone rings the doorbell, or if someone is detected on your property

# APPS: USEFUL INFORMATION

## DOWNLOADING AN APP: EXAMPLE WITH THE HOME + CONTROL APP

- Prerequisite: having a working router or Wi-Fi router.
- Having downloaded the app, follow the on-screen instructions step-by-step to create an account and set up your customer's installation.

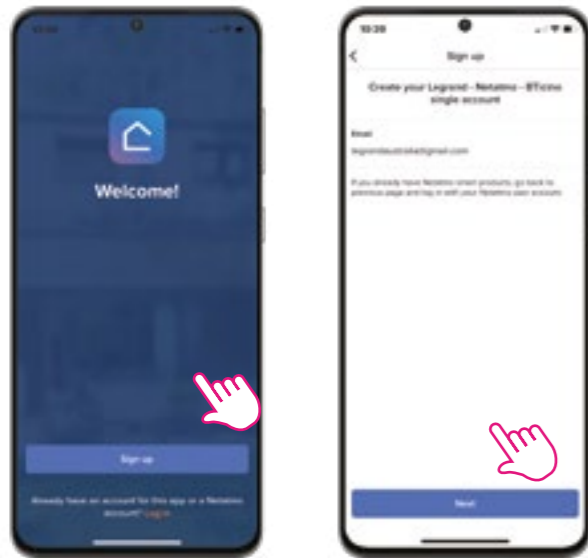
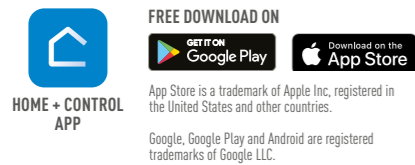

1-Tap **Create account.**

2-Tap **Next** and follow the on-screen instructions.

### IMPORTANT

#### IF YOU ARE WORKING ALONE ON SITE, USE AN ANDROID SMARTPHONE.

**Do you only have an iPhone or iPad?** Then avoid configuring the installation in the Home + Control app because your customer will not be able to scan the HomeKit code on their iPhone.

#### IF YOUR CUSTOMER IS WITH YOU, AND THEY HAVE AN IPHONE

Download the Home + Control app and configure the installation with their iPhone. This will ensure you scan the Apple HomeKit unique setup code directly on their iPhone (see next page).

## PERSONALISING AN INSTALLATION: EXAMPLE WITH THE HOME + SECURITY APP

- The Home + Security app is used to set up all Netatmo security products.
- It is possible to personalise known faces, camera alert zones or automatic siren activation on a Smart Alarm System with Camera, for example.

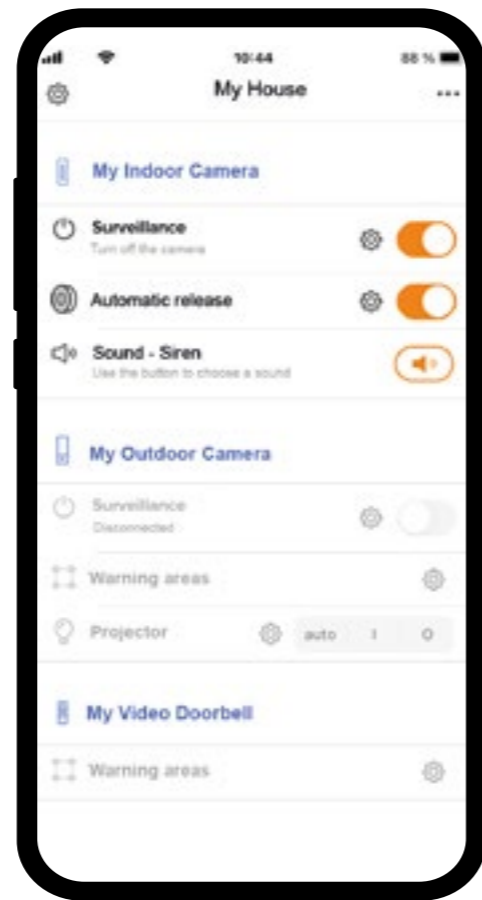

## TEMPERATURE SCHEDULES IN THE HOME + CONTROL APP

- A temperature schedule is a series of **time periods** each comprising a **temperature setting** (see examples below).
- It is possible to have a different schedule for **each day** and **each room**.

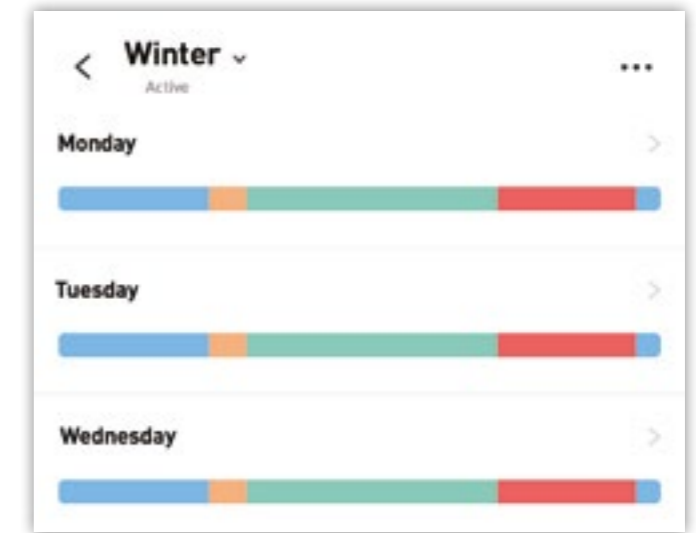

Displaying schedules in the Home + Control app: coloured zones correspond to the selected temperature setting for each time period.

Default settings, customisable



**Comfort**

Desired temperature setting when **rooms are occupied**.  
 E.g. from 7 am to 8 am and 6 pm to 10 pm every weekday and from 9 am to 11 pm at the weekend.



**Comfort+**

Desired temperature setting for **a specific room**.  
 E.g. from 6 am to 7 am in the bathroom every day of the week except the weekend.



**Night**

Desired temperature setting for **night time**.  
 E.g. from 10 pm to 6 am every weekday and from 11 pm to 9 am at the weekend.



**Eco**

Desired temperature setting for **day time**.  
 E.g. from 8 am to 6 pm every day of the week except the weekend.



**Pers**

It is possible to **create other personalised temperature settings**.

## APPS: USEFUL INFORMATION (continued)

### MAKE THE INSTALLATION AVAILABLE TO YOUR CUSTOMER AND DELETE YOUR ACCESS DETAILS

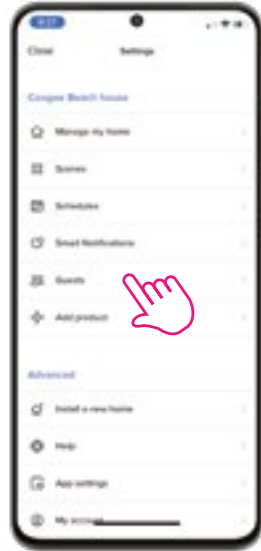

1-Tap **Manage guests** and follow the step-by-step instructions.

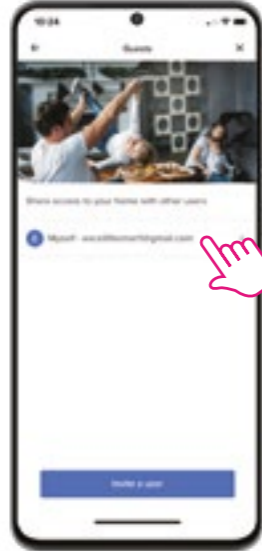

2-Select **your own access details**.

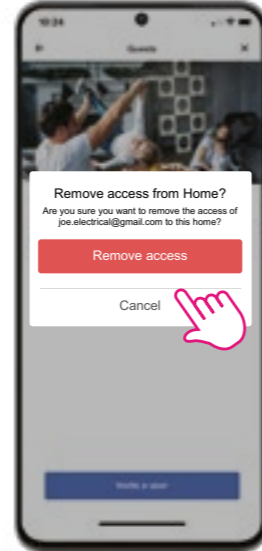

3-Remove them from the list.

> The installation configuration is still available and will appear in your customer's Home + Control app when they download it.

### SHARE THE HOME + CONTROL APP BETWEEN SEVERAL USERS

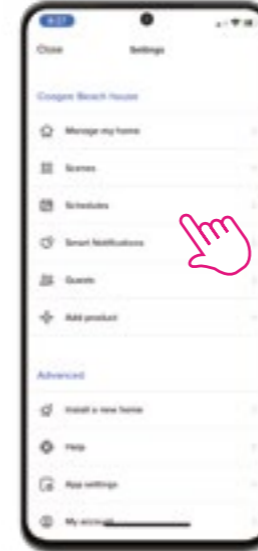

1-Tap **Manage guests**.



2-Tap **Share access to your home with other users** and follow the step-by-step instructions.

### CONTROL YOUR MAIN HOME AND YOUR SECOND HOME FROM THE HOME + CONTROL APP

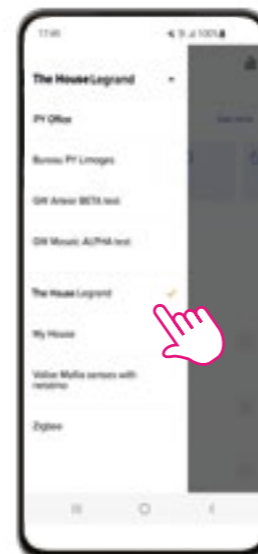



Go to the list of homes<sup>[1]</sup> and select the home you wish to control

[1] **Android:** settings, at the top of the screen  
**iPhone:** in the centre, at the top of the home screen

# INTEROPERABILITY

## VOICE ASSISTANTS

To expand the applications for the connected devices in your home, an ever-increasing number of our products are compatible with the main commercially-available voice assistants.

			
Excel Life Smart/Arteor with Netatmo/Living Now with Netatmo	✓	✓	✓
CX <sup>3</sup> with Netatmo: latching relay/contactor/gateway power module	✓	✓	✓
Netatmo Outdoor and Indoor Smart Cameras	✓	✓	✓
Classe 300EOS			✓
Aqua Life with Netatmo	✓	✓	✓
Smarter with Netatmo Thermostats	✓	✓	✓
Netatmo Smart Home Weather Station		✓	✓

iOS: Legrand's "with Netatmo" solution requires an iPhone, iPad or an iPod Touch

To control this HomeKit-compatible accessory, we recommend using the latest version of iOS or iPadOS.

In order to control this accessory automatically from outside the home, you need a HomePod, Apple TV or iPad configured as a hub. It is advisable to update to the latest version of both the software and the operating system.

iPhone, iPod and iPad are trademarks of Apple Inc, registered in the United States and other countries. App Store is a trademark of Apple Inc, registered in the United States and other countries. HomeKit and iPadOS are trademarks of Apple Inc. iOS is a trademark of Cisco registered in the United States and other countries and used under licence.

ANDROID: Android 5.0 minimum required with Google Play access.

WEBAPP: PC & Mac

Google, Android, and Google Play are trademarks of Google LLC

Amazon, Alexa and their associated logos are trademarks of Amazon.com, Inc. or its subsidiaries.

## Notes

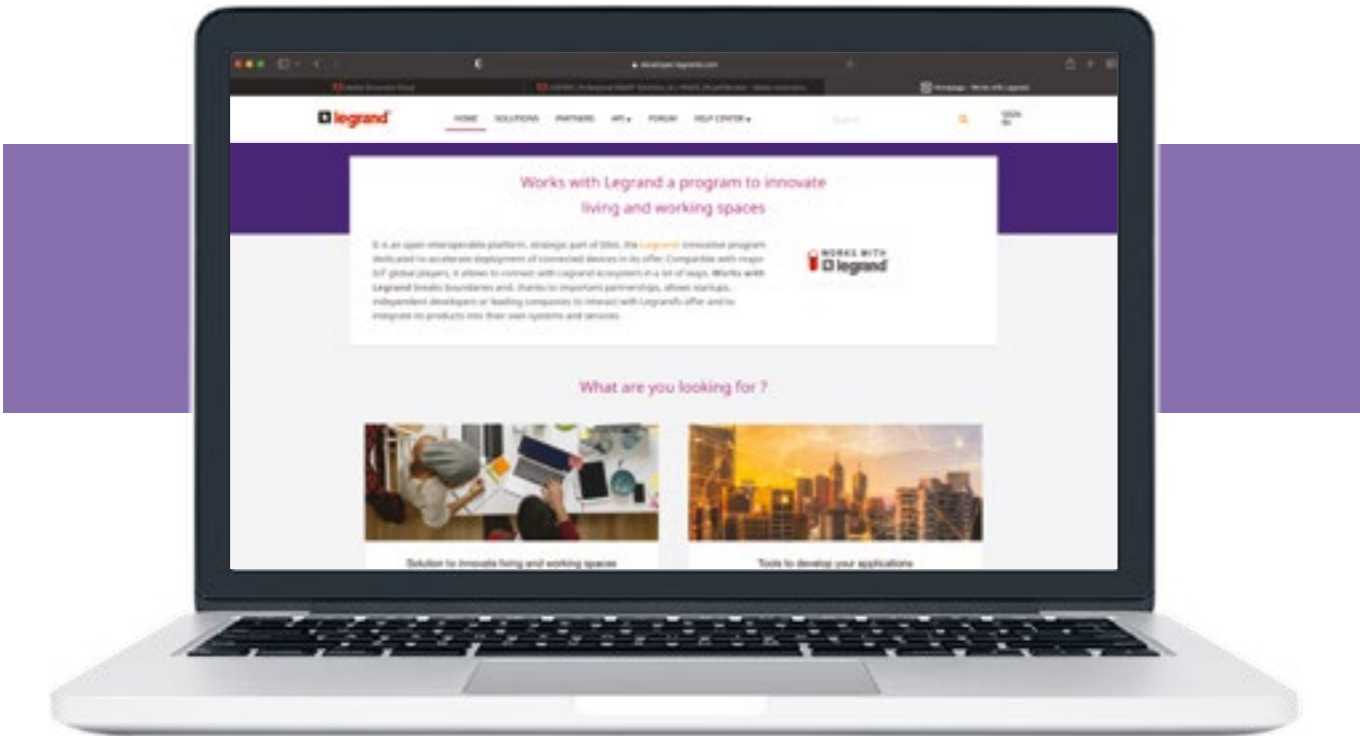



## FOLLOW US ON



[facebook.com/LegrandAustralia](https://facebook.com/LegrandAustralia)  
[facebook.com/Legrandnz](https://facebook.com/Legrandnz)



[au.linkedin.com/company/legrandaus](https://au.linkedin.com/company/legrandaus)  
[linkedin.com/company/hpm-legrand-new-zealand](https://linkedin.com/company/hpm-legrand-new-zealand)



[instagram.com/hpmlegrand/](https://instagram.com/hpmlegrand/)



### **Legrand Australia**

Building 4, Nexus Industry Park  
43-47 Lyn Pde Prestons NSW 2170  
1300 369 777

[www.legrand.com.au](https://www.legrand.com.au)

### **Legrand New Zealand**

106-124 Target Road Glenfield  
Auckland 0627 New Zealand  
0800 476 009

[www.legrand.co.nz](https://www.legrand.co.nz)